



# Turb PLUS 2000

PROCESS TURBIDIMETER



a xylem brand



## Contents

<b>1.0 Safety instructions .....</b>	<b>5</b>
1.1 Safety Information .....	5
1.1.1 Safety information in the operating manual .....	5
1.1.2 Safety signs on the product .....	5
1.2 Safe operation .....	6
1.2.1 Authorized use .....	6
1.2.2 Requirements for safe operation .....	6
1.2.3 Unauthorized use .....	6
<b>2.0 Technical Data.....</b>	<b>7</b>
<b>3.0 Overview .....</b>	<b>8</b>
3.1 The Turb PLUS 2000 - Product Description .....	8
3.2 The Display.....	9
3.3 The Touchpad .....	9
3.4 Vapor Purge .....	10
<b>4.0 Unpacking and Inspection.....</b>	<b>10</b>
<b>5.0 Installation .....</b>	<b>11</b>
5.1 Site Selection.....	12
5.2 Mounting.....	12
5.3 Plumbing & Assembly .....	15
5.3.1 Initial Assembly .....	15
5.3.2 Connection of Turb PLUS 2000 to System Plumbing .....	15
5.3.3 Connecting the drain.....	17
5.3.4 Connecting the water intake .....	17
5.4 Electrical Connections.....	18
5.4.1 Electrical Power Connection.....	19
5.4.2 Terminal Block (P1) Connections: .....	19
5.4.3 Closing the Junction Box .....	21
<b>6.0 Setup, Configuration and Calibration .....</b>	<b>22</b>
6.1 Modes of Operation.....	23
6.2 Configuring the Turb PLUS 2000.....	25
6.2.1 Configuring the 4-20mA Output.....	26
6.2.2 Baud Rate - Selecting the RS-485 Baud Rate .....	27
6.2.3 Modbus Address – Address Selection.....	28
6.2.4 Configuring the Alarms .....	28
6.2.5 Offset – Offset Reading Adjustment.....	31
6.2.6 Access Code - Setting Security .....	31
6.2.7 Signal Averaging - Setting Speed of Response .....	32

6.2.8 Display Resolution - Setting Resolution .....	33
6.2.9 LCD Brightness - Setting the LCD backlight brightness.....	33
6.2.10 Display Units - Setting Displayed Units .....	34
6.2.11 Ultrasonic Cleaning - Cleaning Function .....	34
6.2.12 Modbus Parity & Modbus Stop Bits - RS485 Parameters.....	35
6.2.13 4mA and 20mA Adjustment .....	35
6.2.14 Instrument ID – Instrument Unique Number Identification .....	37
6.2.15 Logging Interval – Setting the interval for logged files .....	37
6.2.16 Download Logged Files – Select to Download.....	38
6.2.17 Date and Time – Setting of Instrument Time & Date .....	38
6.2.18 Update Software - Install Latest Software or Change Range .....	41
6.3 Calibrating the Turb PLUS 2000, CAL Mode.....	42
6.3.1 Calibration Standards (0-100 NTU range).....	43
6.3.2 Indexing Calibration Cuvettes .....	44
6.3.3 Calibration Procedures.....	44
6.3.4 Abort Calibration.....	45
6.3.5 Calibration Failure .....	46
6.3.6 Instrument Offset.....	46
<b>7.0 Operation .....</b>	<b>47</b>
7.1 Installing or Replacing the Desiccant Pouch .....	47
7.2 Starting the System .....	48
7.3 Routine Measurement: AUTO Mode.....	49
7.4 Data Retrieval.....	49
7.4.1 USB Connection.....	49
7.4.2 File Downloads.....	49
7.4.3 Modbus Communication .....	50
7.5 Patented Ultrasonic Cleaning .....	50
7.6 Condensation on Cuvette.....	51
7.7 Cleaning the Flow-Through Cuvette .....	53
7.8 Replacing the Source Lamp.....	53
7.9 Optional Factory Installed 24V Option .....	53
<b>8.0 Troubleshooting.....</b>	<b>54</b>
8.1 Turb PLUS 2000 Fault Detection .....	54
8.1.1 Warnings .....	54
8.1.2 Errors.....	54
8.1.3 Failures.....	54
8.2 Diagnostic Table.....	55
8.3 Bubbles in the Sample .....	55
8.4 Technical and Customer Assistance.....	56

## 1.0 Safety instructions

### 1.1 Safety Information

#### 1.1.1 Safety information in the operating manual

This operating manual provides important information on the safe operation of the product. Read this operating manual thoroughly and make yourself familiar with the product before putting it into operation or working with it. The operating manual must be kept in the vicinity of the product so you can always find the information you need.

Important safety instructions are highlighted in this operating manual. They are indicated by the warning symbol (triangle) in the left column. The signal word (e.g. "CAUTION") indicates the level of danger.

This manual contains safety and use instructions that must be followed during the installation, commissioning, operation, care and maintenance, and service of the Turb PLUS 2000. All responsible personnel must read this manual prior to working with this instrument and should familiarize themselves with the following safety symbols, signals, and pictorials.



**This is a safety-alert symbol.**

- The safety alert symbol is shown alone or used with a signal word (DANGER, WARNING or CAUTION), a pictorial and/or a safety message to alert you to hazards.
- When you see this symbol alone or with a signal word on this instrument or in this Manual, be alert to the potential for death or serious personal injury.



**DANGER**

indicates a potentially or imminently hazardous situation which, if not avoided, will result in serious injury or death.



**WARNING**

indicates a possibly dangerous situation that can lead to serious (irreversible) injury or death if the safety instruction is not followed.



**CAUTION**

indicates a possibly dangerous situation that can lead to slight (reversible) injury if the safety instruction is not followed.

**NOTICE**

indicates a situation where goods might be damaged if the actions mentioned are not taken..

#### 1.1.2 Safety signs on the product

Please read all labels and tags attached to the instrument. Personal injury or damage to the instrument could occur if not observed.



This pictorial alerts you to the need to read the Manual.



This pictorial alerts you to electricity, electrocution and shock hazards.

## 1.2 Safe operation

### 1.2.1 Authorized use

The authorized use of the Turb PLUS 2000 is its use for turbidity measurement. Only the operation and running of the Turb PLUS 2000 according to the instructions and technical specifications given in this operating manual is authorized (see section 2.0). Any other use is considered unauthorized.

With unauthorized use, the protection type supported by the instrument can be adversely affected.

### 1.2.2 Requirements for safe operation

Note the following points for safe operation:

- The product may only be operated according to the authorized use specified above.
- The product may only be operated under the environmental conditions mentioned in this operating manual.
- The product may only be supplied with power by the energy sources mentioned in this operating manual.
- The product may only be opened if this is explicitly described in this operating manual (example: connecting electrical lines to the terminal strip).

### 1.2.3 Unauthorized use

The product must not be put into operation if:

- it is visibly damaged (e.g. after being transported)
- it was stored under adverse conditions for a lengthy period of time (storing conditions, see section 2.0).

## 2.0 Technical Data

<b>Measurement Range</b>	0 – 100 NTU, factory configured Model #28052 (Infrared) & Model #28053 (White Light) 0-10 NTU & 0-1000 NTU optional ranges (loaded on USB thumb drive)
<b>Accuracy</b>	±2% of reading or ±0.02 NTU below 40 NTU whichever is greater (0-100 and 0-1000 ranges) ±5% of reading above 40 NTU (0-100 and 0-1000 NTU ranges) ±2% of reading or ±0.02 NTU (0-10 NTU range)
<b>Resolution</b>	0.0001 NTU (below 10 NTU)
<b>Response Time</b>	Adjustable
<b>Display</b>	Multi-Line Liquid Crystal Backlit Display
<b>Alarms</b>	Two Programmable, 120-240VAC 2A Form C Relay
<b>Analog Output</b>	Powered 4-20 mA, 1000 Ω drive
<b>Communications Port</b>	Bi-directional RS-485, Modbus RTU
<b>Data Storage</b>	16 Gigabytes download via USB flash drive
<b>Software</b>	Upgradeable via USB flash drive
<b>Maximum Water Pressure</b>	Integral pressure regulator rated 7 bar (101.5 PSI)
<b>Flow Rate</b>	100 ml/min. – 1.5 liter/min. (.026-.40 Gal/min)
<b>Operating Temperature</b>	1°C – 50°C (34°F – 122°F)
<b>Wetted Materials</b>	Nylon, Borosilicate Glass, Silicone, Polypropylene, Stainless Steel, Viton, Acetyl
<b>Sample Temperature</b>	1°C – 50°C (34°F – 122°F)
<b>Power Supply</b>	100 – 240 VAC, 47 – 63 Hz, 80VA
<b>Insulation Rating</b>	Double Insulated, Pollution Degree 2, Overvoltage Category II
<b>Environmental Conditions</b>	Not recommended for outdoor use. Altitude up to 2000 meters Up to 95 % RH (non-condensing)
<b>Enclosure</b>	ABS
<b>Regulatory Compliance And Certifications</b>	White Light Version compliant to U.S. EPA 180.1 Infrared Version compliant to ISO 7027 and DIN 27027 CE Approved, LC listed to UL 61010-1 3rd Edition: 2012 LC: Certified to CSA 22.2 No.61010-1-12: 2012
<b>Instrument Weight</b>	1.8 kg (4.0 lbs.)
<b>Shipping Weight</b>	2.8 kg (6.2 lbs.)
<b>Limited Warranty</b>	2 Years from date of invoice

### 3.0 Overview

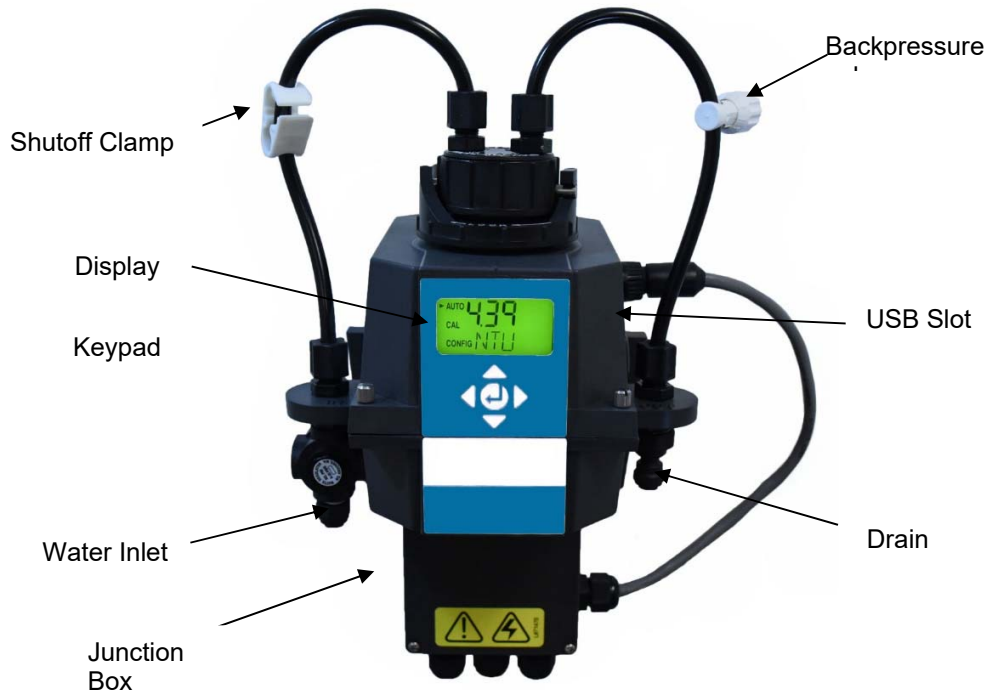

#### 3.1 The Turb PLUS 2000 - Product Description

The Turb PLUS 2000 process turbidimeter allows for the measurement of the turbidity of process water on-line. The Turb PLUS 2000 works by nephelometry; which means it measures reflected light at 90° incident to the light beam. The white light Turb PLUS 2000 has been designed to meet the design criteria specified by the US EPA 180.1 on turbidity measurement. The infrared Turb PLUS 2000 was designed to meet the design criteria specified in DIN EN ISO 7027-1 for the measurement of the turbidity of a sample. Both models have long life lamps.

All models have ultrasonic cleaning. See section 7.5 for more information.

A pressure regulator on the incoming line is a standard on all Turb PLUS 2000 instruments and will reduce pressures up to 7 bar (101.5 PSI) down to 1.03 bar (15 PSI).

The Turb PLUS 2000 instruments are fully equipped with isolated 4-20mA, Modbus, two alarms and ultrasonic cleaning. The only option is a flow alarm which must be factory installed.



## 3.2 The Display

Figure 1 illustrates all the items that can appear on the display.

- The upper row of the display is used for reporting the turbidity levels and to provide user guidance in the customer setting routine.
- The lower row of the display is used to communicate error messages and provide useful guidance.
- The display has two icons that are used to indicate the use of access code and offset mode.
- In addition, mode arrows are used to indicate the current instrument operating mode: AUTO (normal operation), CAL (calibration) and CONFIG (configuration).

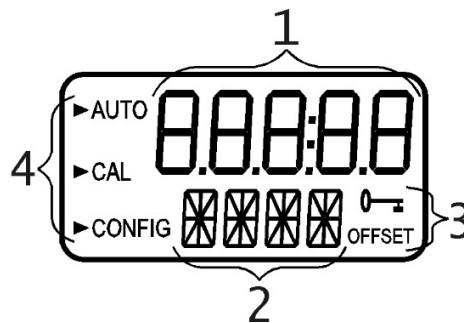

Figure 1: Display Used in the Instrument  
All items used on the display are shown in this figure

## 3.3 The Touchpad

Figure 2 illustrates the touchpad. The touchpad has five buttons arranged in a star pattern with a center button.

- Right ▶ and left ◀ buttons allow scrolling forward and backward through the menus
- Up ▲ and down ▼ buttons are used to change selections
- The center button ↻ is used to accept a change.

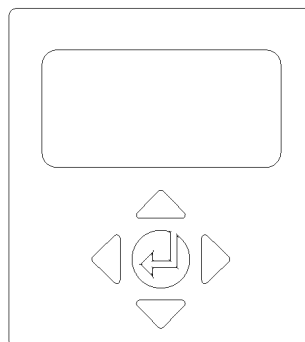

Figure 2: Touchpad

### 3.4 Vapor Purge

The Turb PLUS 2000 is equipped with a continuous Vapor Purge system.

A replaceable desiccant pouch in the lower portion of the instrument dries the air. System heat is used to warm the air. A fan inside the instrument continuously circulates heated dry air around the optical well and the flow through cuvette. This feature eliminates the need for a dry purge line.



The Turb PLUS 2000 monitors the replaceable desiccant pouch condition continuously. The LCD display will show DESC on the lower line in the event that the desiccant pouch needs replacement. Replacement desiccant pouches are available from Xylem Analytics Germany. See section 7.1 Installing or Replacing the Desiccant Pouch..

The Turb PLUS 2000 creates its own internal environment. In this controlled environment, condensation cannot form. The cuvette is essentially bathed in warm, dry air.

## 4.0 Unpacking and Inspection

The table below indicates the items in the turbidimeter shipment.

Item	Quantity
Turb PLUS 2000 Turbidimeter with Flow Through Assembly	1
Field Terminal Box with Interconnect cable	1
Owner's and User's Manual	1
Desiccant Pack	1
Tubing Kit: 1-shutoff clamp 1-backpressure valve 2-connecting tubing with fittings for flow through assembly	1
Screwdriver to make electrical connections in the junction box	1
USB Flash Drive (Including files for optional ranges and user manual)	1

### NOTICE

**Remove the instrument from the packing carton. Carefully inspect all items to ensure that no visible damage has occurred during shipment. If the items received do not match the order, please immediately contact Xylem Analytics Germany.**

## 5.0 Installation



### **DANGER**

The Turb PLUS 2000 must be mounted and installed in a suitable location, plumbed to the sample water source (section 3.34), and hard-wired to electrical power (section 3.4). Installation **MUST** be performed by qualified technicians, including licensed electricians, following all instructions, complying with all local, state, federal and other governmental requirements, and with all building and construction codes and standards.

If you have any questions or are uncertain about proper site location, installation or connection of the Turb PLUS 2000, please contact Xylem Analytics Germany.



### **DANGER**

Failure to follow all installation instructions and requirements risks possible death, personal injury, property damage, and failure of the instrument to perform as intended.

Installation **MUST** be performed by qualified technicians, including licensed electricians, following all instructions, complying with all local, state, federal and other governmental requirements, and with all building and construction codes and standards.

Turb PLUS 2000 is electrically powered. **ALWAYS** take proper precautions to recognize, evaluate, and control electrical hazards during installation, programming, use and service/maintenance.

Use **ONLY** with water free of corrosive chemicals or other hazardous substances.

**ALWAYS** leak check plumbing connections following installation and on a regular basis.

Turb PLUS 2000 **MUST** be installed in an area isolated from vibration, and not susceptible to freezing or temperature extremes. Mount on any suitable vertical and flat surface that can support the product's weight.

Keep installation and work area clean, well-lighted, free of clutter and distractions, and accessible only by authorized personnel and workers.

Turb PLUS 2000 must be located in an accessible and well-lighted area for use, servicing, repair or replacement by authorized personnel.

## 5.1 Site Selection



Choose a site that is accessible and well-lighted for use, servicing, repair or replacement by authorized personnel.

Turb PLUS 2000 should be located and mounted within 2-3 meters (6 to 10 ft) of the sampling point to ensure a quick response time.

Installation/mounting site must be isolated from vibration, and not susceptible to freezing or temperature extremes.

The site must have a suitable vertical and flat surface that can support the product's weight and service operations 5kg (10lbs).

There should be 20 cm (8 in) free area above the instrument. This will ensure enough room for calibration and cuvette maintenance.

The site must allow for mounting Turb PLUS 2000 with the front display positioned at eye level 1.4 to 2 meters (approximately 4.5 to 6.5 feet from the floor).

Turb PLUS 2000 is designed to have the Junction Box cradled under the upper portion of the instrument – Select a site with enough space for proper configuration when mounted.

## 5.2 Mounting



Described is for installation to a concrete surface. If needed contact Xylem Analytics Germany for instruction to install on other surfaces.

Tools required:

- Appropriate screwdriver or driver gun.
- Mounting Template – last page of this Manual.
- Masking tape for attaching Mounting Template to the wall.
- Any tools required by wall anchor manufacturer if used.

Hardware required:

- 4 Mounting screws for instrument enclosure - M6 (1/4"). Either use concrete screws or use a wall anchors & the supplied screws.
- 2 Mounting screws for terminal junction box - M4 (#8). Either use concrete screws or use a wall anchors & the supplied screws.

1. Using masking tape, affix the mounting template to the vertical surface of the selected mounting location and mark location for screws.
  - The Turb PLUS 2000 is designed for **vertical wall mounting**. If wall mounting is not practical, the instrument can be mounted on any suitable vertical, flat surface.
  - Make sure that the mounting position is level.
2. The overall mounting dimensions of the Turb PLUS 2000 are shown in Figure 3, below. Measure to confirm that the mounting location has sufficient space and that there is at least 20 cm (8 in) free area above the instrument when mounted. This will ensure enough room for calibration and cuvette maintenance.
3. Carefully remove the mounting template from the wall, keeping it in one piece for future reference and use.
4. Install wall anchors (if needed) - Following manufacturer's instructions for the wall anchors, and using the mounting template as a guide, insert wall anchors for each mounting position.
5. **Mount the Junction Box First.** The Turb PLUS 2000 is designed to have the Junction Box cradled under the upper portion of the instrument containing the keypad and display.
  - a. Position the Junction Box of the Turb PLUS 2000 to match the 2 lower wall anchors.
  - b. Mount the Junction Box first by inserting the M4 (#8) screws through the 2 inside the Junction Box. Use wall anchors as needed.
  - c. Using the screwdriver, hand-tighten both screws, ensuring that the Junction Box is firmly and securely attached.
6. **Mount the upper keypad and display section.** After securely mounting the junction box, mount the upper portion of the Turb PLUS 2000 so that the junction box is cradled under the upper portion.
  - a. Position the upper portion of the Turb PLUS 2000 to match the remaining holes or wall anchors.
  - b. Insert M6 (1/4") screws through the 4 tabs on the upper portion of the Turb PLUS 2000 and into the wall anchors.
  - c. Using the screwdriver or driver gun, to tighten the screws, ensuring that the upper portion is firmly and securely attached.
7. Confirm that Turb PLUS 2000 is securely mounted to the wall (or vertical surface) and positioned:
  - Within 2-3 meters (6 to 10 ft) of the sampling point to ensure a quick response time.
  - Isolated from vibration, and not susceptible to freezing or temperature extremes.
  - Suitable vertical and flat surface that can support the product's weight 5 kg (10lbs).
  - 20 cm (8 in) free area above the instrument, allowing room for calibration and cuvette maintenance.
  - The front display should be positioned at eye level or a suitable level to read and reach controls - approximately 1.4 Meters (4.5 feet) to 2 meters (6.5 feet) from the floor.
  - Confirm that the unit is level.

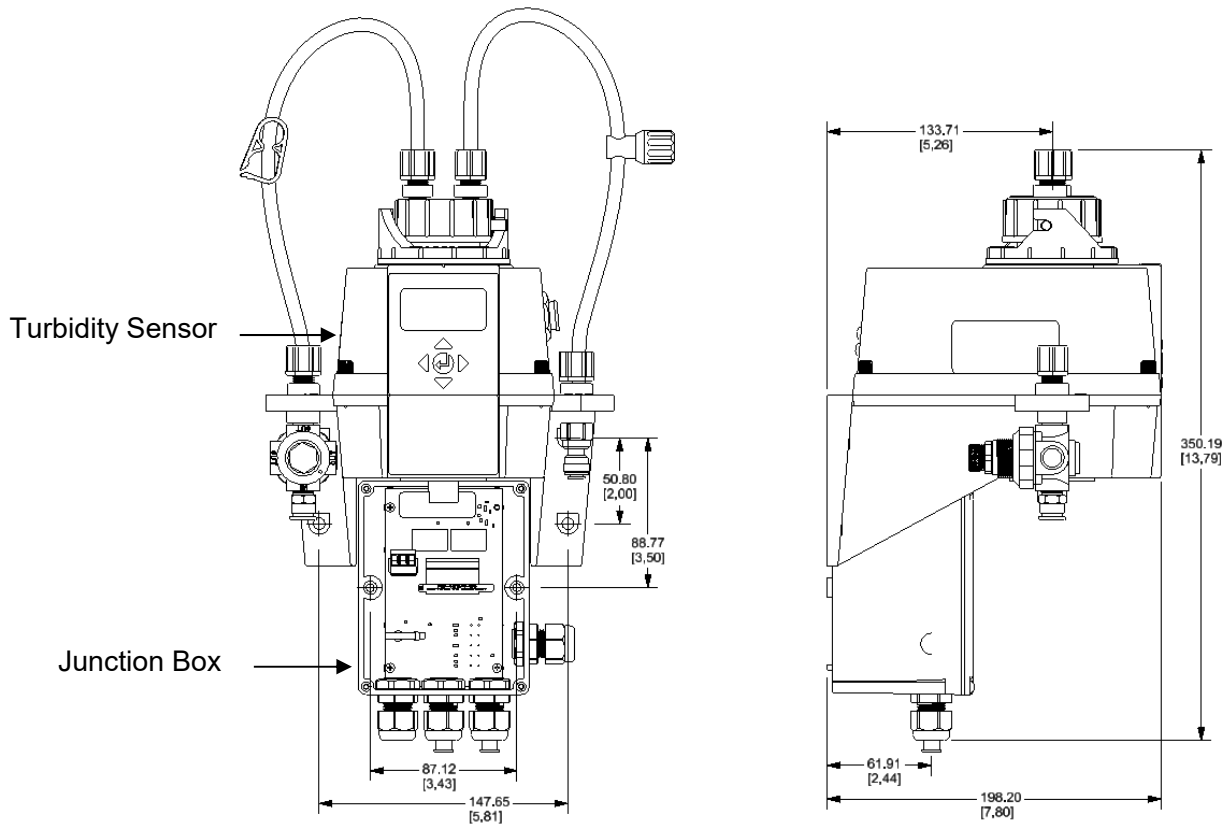

Figure 3: Mounting Dimensions of the Instrument

## 5.3 Plumbing & Assembly

### NOTICE

To avoid property damage or damage to the product, **ONLY** qualified personnel should perform plumbing connections following all instructions, complying with all local, state, federal and other governmental requirements, and with all building and construction codes and standards.

Turb PLUS 2000 requires very little head pressure to operate 6.9kPa (1 PSI).

The flow-through cuvette is rated for a flow of 100ml/min. - 1 liter/min. (0.026-0.26Gal/min).

The integral pressure regulator is rated for a **MAXIMUM** pressure of 7 bar (101.5 PSI).

The **MAXIMUM** allowable fluid temperature is 50°C (122°F).

### 5.3.1 Initial Assembly

The IN and OUT tubes must be connected to the Turb PLUS 2000 before the system is connected to the sample water source and drain.

1. Identify the IN tube. This is the tube with the white ratcheting clamp.
2. Install the IN tube between the sensor mounting earmarked IN and the flow head connection marked IN. Secure both ends tightly.
3. Identify the OUT tube. This is the tube with the rotary backpressure valve.
4. Install the OUT tube between the sensor mounting earmarked OUT and the flow head connection marked OUT. Secure both ends tightly.

### 5.3.2 Connection of Turb PLUS 2000 to System Plumbing

#### Requirements

- Use ¼ inch OD flexible tubing (polyethylene or polypropylene) for connecting the Turb PLUS 2000.

### NOTICE

**If tubing may be exposed to sunlight, use opaque tubing to limit algae growth.**

Turb PLUS 2000 has push-to-connect fittings for water inlet and drain connections.

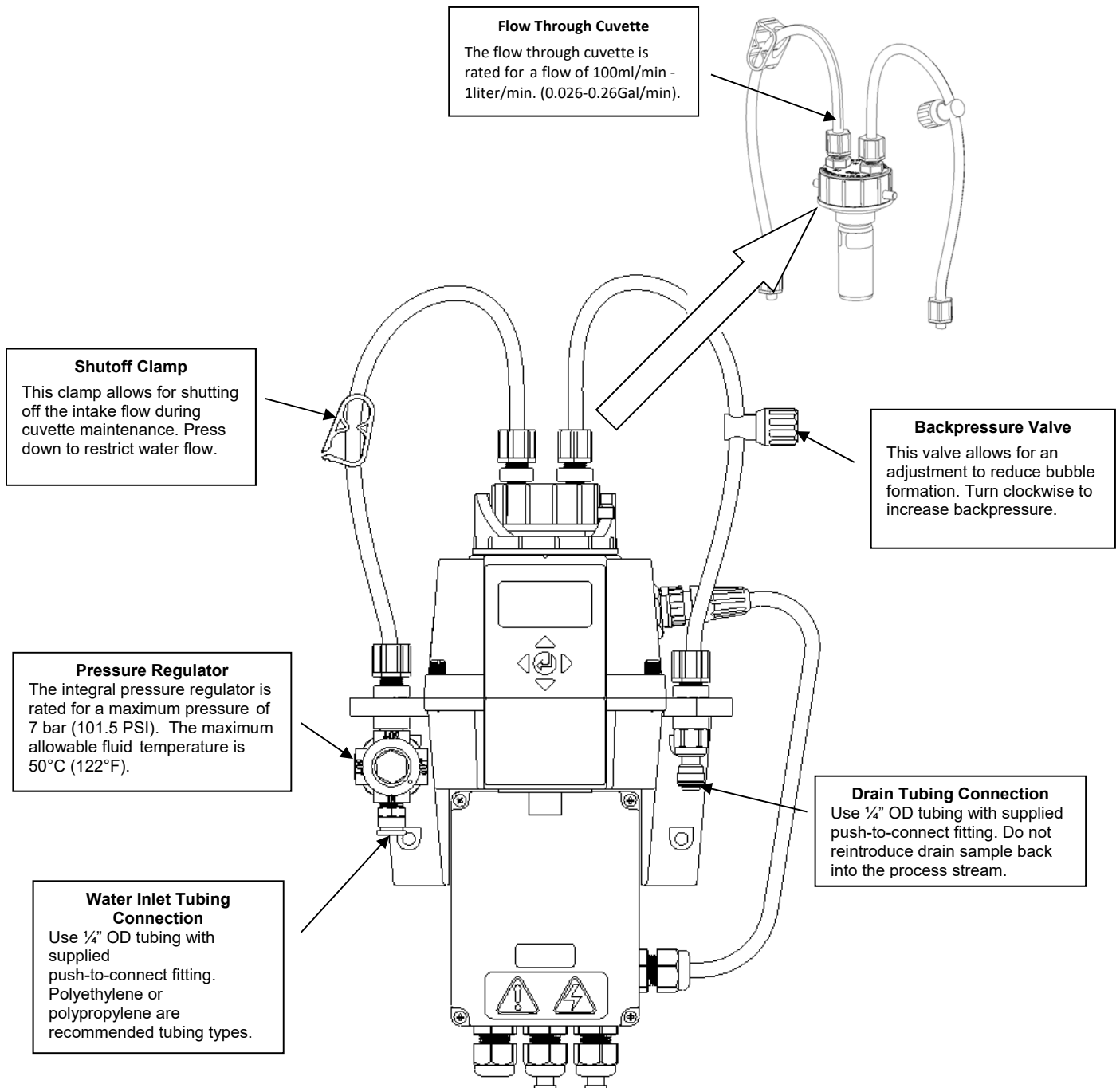

Figure 4: Instrument Parts Identification



### 5.3.3 Connecting the drain

**CAUTION**

**Turb PLUS 2000 drain tubing MUST be routed to a suitable sanitary sewer drain. Wetted materials are not FDA approved.**

**DO NOT return the drain sample or any water run through Turb PLUS 2000 into the process stream or into any potable water supply, as this results in contamination of drinking water.**

1. Select a length of ¼ inch OD flexible tubing (Polyethylene or polypropylene) long enough to directly connect the Turb PLUS 2000 drain connection point to a suitable sanitary sewer drain. Avoid unnecessary bends or sags in the tubing. Make sure there are no kinks, twists, breaks, or damage of any kind in the tubing.
2. Using a sharp utility knife, cut the end of the tubing square. Remove any burrs or sharp edges before inserting into fitting.
3. Place a piece of tape ½ inch from the end of the tube to indicate how far the tube should be inserted.
4. Push the tube into the Quick-Connect fitting on the right facing side of the Turb PLUS 2000, as shown in Figure 4.
5. Check to confirm that tube is pushed fully against the tube stop. Gently but firmly pull on the tube to check that it is secure.
6. Connect the other end of the tube to a suitable sanitary drain or trench following proper plumbing techniques applicable to your facility and configuration.

### 5.3.4 Connecting the water intake

**CAUTION**

**Use Turb PLUS 2000 ONLY with water. Connect water intake ONLY to water free of corrosive chemicals or other hazardous substances.**



Xylem Analytics Germany accepts no responsibility for damage caused by the introduction of vapors, fluids or other materials into the instrument process stream which is not compatible with the instrument's wetted materials. A list of the wetted materials can be found in the specifications on page 2 of this manual.

1. Select a length of ¼ inch OD flexible tubing (Polyethylene or polypropylene) long enough to directly connect the Turb PLUS 2000 water inlet connection point to water sampling point. Avoid unnecessary bends or sags in the tubing. Make sure there are no kinks, twists, breaks, or damage of any kind in the tubing.
2. Using a sharp utility knife, cut the end of the tubing square. Remove any burrs or sharp edges before inserting into fitting.
3. Place a piece of tape ½ inch from the end of the tube to indicate how far the tube should be inserted.
4. Push the tube into the Quick-Connect fitting on the left facing side of the Turb PLUS 2000, as shown in Figure 4.
5. Check to confirm that tube is pushed fully against the tube stop. Gently but firmly pull on the tube to check that it is secure.

6. Connect the other end of the tube to the water sample source following proper plumbing techniques applicable to your facility and configuration.

**NOTICE**

**After completing water inlet and drain connections, check all tubing and connections for any leaks, weeping, breaks or defects of any kind. Repair/replace as needed.**

## 5.4 Electrical Connections

**DANGER**

**High voltage and electrocution hazard: To avoid risks possible death, personal injury, property damage, and failure of the instrument to perform as intended only licensed and qualified electricians should install the instrument following all codes, regulations, standards and instructions.**

Turb PLUS 2000 is electrically powered. Installation **MUST** be performed by licensed electrician following all instructions and comply with all local, state, federal and other governmental requirements, and with all building and construction codes and standards for all electrical connections and for installation of electrical connections to and between the instrument and any peripheral devices.

**ALWAYS** take proper precautions to recognize, evaluate, and control electrical hazards during installation, programming, use and service/maintenance.

**Requirements:**

- The Turb PLUS 2000 is equipped with a 100-240 VAC, 47-63 Hz switching power supply. **BEFORE installing, verify that the line voltage falls within these specifications.**
- A breaker or method of disconnecting power must be placed within 2 meters (6 feet) of the Turb PLUS 2000.
- While making connections, see Figure 5. **The Turb PLUS 2000 is not supplied with a power cord.**
- All of the electrical connections to the instrument are made through the Turb PLUS 2000 Junction Box (see Figure 5), which should be located directly under the sensor portion of the instrument.
- The power cable glands will accept cable diameters from 5.8mm (.230 in) up to 10 mm (.395 in.).
- All terminals are designed to accept wires in the range of 12-30 AWG. All wires should be stripped to a length of 6 mm (¼ in).
- A strain relief strap is provided to reduce tension on the power terminals.
- The connections are labeled within the terminal box and are self-descriptive (see Figure 5).
- Plugs are inserted into the alarm and 4-20mA/RS-485 cable glands when shipped, to ensure a watertight seal. These plugs should be removed and discarded when cabling to either of these connections.
- **Maintain watertight seal.** It is the owner's and installer's responsibility to assure that the watertight seal is maintained after the terminal box has been wired for operation. Failure to properly tighten any of the cable glands around a cable or plug can create an electrical shock/electrocution hazard.

### 5.4.1 Electrical Power Connection

Make all connections at Junction Box and securely close BEFORE making connections to a power source and energizing Turb PLUS 2000.

**DANGER**

**To avoid risks of possible death, personal injury, property damage, and failure of the instrument to perform as intended ONLY licensed electrician should perform the installation. ALWAYS take proper precautions to recognize, evaluate, and control electrical hazards.**

1. First, make sure that Turb PLUS 2000 is completely de-energized and disconnected from all power.
2. Perform required LOCK OUT/TAG OUT of electrical power.
3. Confirm that a breaker or method of disconnecting power is located All of the electrical connections to the instrument are made through the Turb PLUS 2000 Junction Box (see Figure 5), which should be located directly under the upper portion of the instrument.
4. Carefully open the Turb PLUS 2000 Junction Box (see Figure 5) by removing the four cover screws.
5. With the Junction Box cover removed, the connections are visible as shown in Figure 5.
6. The power cable glands will accept cable diameters from 5.8mm (.230 in) up to 10 mm (.395 in.). All terminals are designed to accept wires in the range of 12-30 AWG.
7. Obtain and cut proper wires to make connections for your specific installation and facility. All wires should be stripped to a length of 6 mm (¼ in).
8. The connections are labeled within the terminal box and are self-descriptive (see Figure 5).
9. Make connections following all local, state, federal and other governmental requirements, and all building and construction codes and standards for all electrical connections.

**DANGER**

**Earth or Ground wire must be connected to a terminal on the Turb PLUS 2000 marked "G".**

10. A strain relief strap is provided to reduce tension on the power terminals. Pull this tight after completing the connections.
11. Perform all checks necessary to confirm proper wiring and safe electrical connection.

### 5.4.2 Terminal Block (P1) Connections:

**DANGER**

**Shut off and disconnect all electrical power BEFORE making or changing any connections. The terminal block (P1) is located close to the power connection.**

The terminal block for RS-485 (Modbus), 4-20 mA and Alarms has spring loaded connections.

To open the connection, insert a 3mm (1/8 in) flat blade screwdriver into the slot right above the electrical connection. Pulling up slightly on the screwdriver opens the terminal block connection. Removing the screwdriver tightens the connection.

There are two stacked rows of connections which are labeled on the PCB. The alarm connections

are on the upper row. The RS-485 and 4-20mA are on the lower row.

These connections are rated for a wire size from 12-28 AWG, either solid or stranded.

### Alarm and I/O Connections

- The Alarm 1 and Alarm 2 relays are mechanical relays rated at 120-240 VAC 2A.
- Note that the relays are labeled NO (Normally Open), NC (Normally Closed) and C (Common).
- The normal condition is with power applied to the Turb PLUS 2000 and in a non-alarm condition. Operation of these alarms is covered in section 4.2.4 *Configuring the Alarms*.
- Connections are labeled beneath the large terminal block. These connections are on the upper row.

### RS-485/Modbus Connection

- The RS-485 half-duplex (2-wire) digital interface operates with differential levels that are not susceptible to electrical interferences. Cable lengths up to 900 meters (3000 ft.) can be implemented.
- The last device on each bus may require terminating with a 120-ohm resistor to eliminate signal reflection on the line.
- Do not run RS-485 cables in the same conduit as power.
- Ensure that power is disconnected prior to making connections to prevent damage to the instrument.
- Connections are labeled beneath the large terminal block. These connections are on the left side on the lower row.

### 4-20 mA Connection



**DANGER**  
**Make sure the Turb PLUS 2000 is disconnected and not powered**  
**BEFORE connecting the 4-20 mA.**

- The 4-20 mA output is driven by a 24 VDC power source and can drive recorder loads up to 1000 ohms.
- This 4-20 mA output is isolated from line power and earth ground.
- Do not run 4-20 mA cables in the same conduit as power.
- Connections are labeled beneath the large terminal block. These connections are on the right side on the lower row.
- Operation of this output is covered in section 4.2.1 *Setting the 4-20 mA*.

### 5.4.3 Closing the Junction Box



**DANGER**

Maintain watertight seal. Always make sure that the Junction Box cover is firmly in place and securely closed. Water infiltration can create electric shock/electrocution hazard and will damage equipment.

Securely close the Junction Box by replacing the cover and all four cover screws.

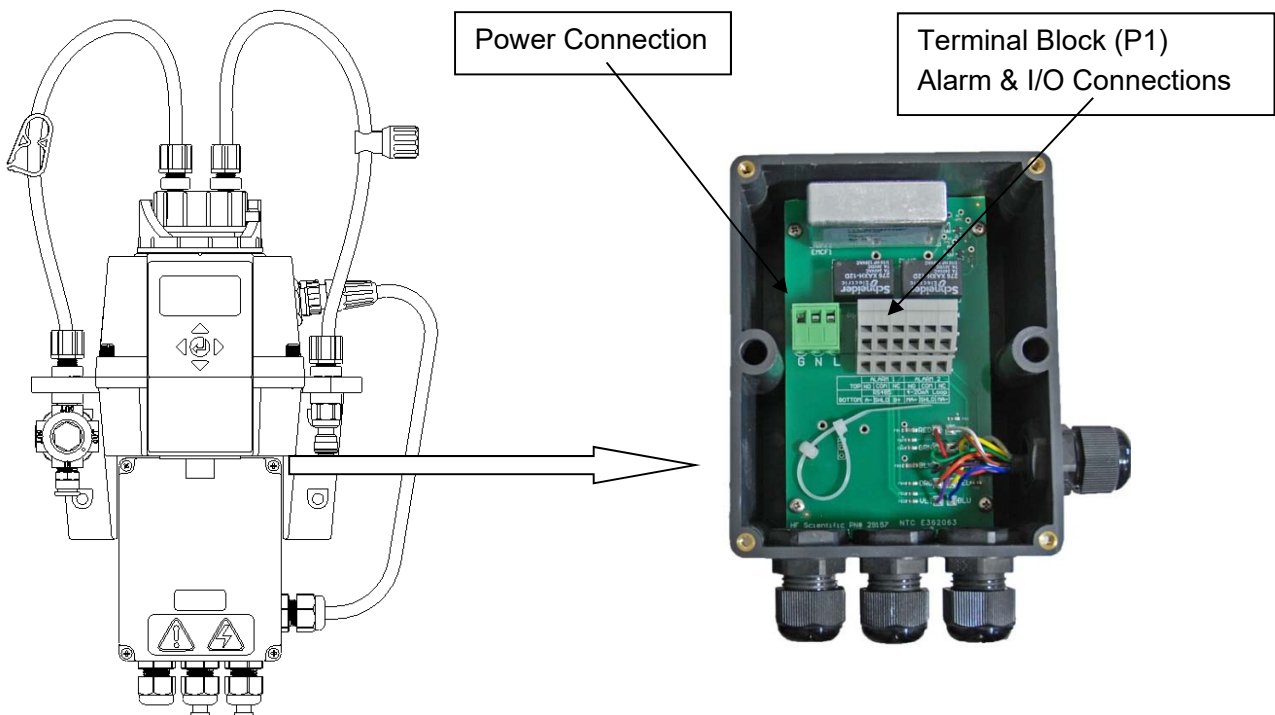

Figure 5: Electrical Connections for the Turb PLUS 2000



Figure 6: Electrical Connections on Terminal Block (P1)

## 6.0 Setup, Configuration and Calibration

### NOTICE

Prior to use for the first time, the supplied desiccant pouch will need to be installed. See section 5.1 Replacing or Installing the Desiccant Pouch.



The instrument is supplied from the factory calibrated for the 0-100 NTU range and can be used right away. If you decide to change the range to either the 0-10 NTU range or the 0-1000 NTU, see section 6.2.18. You will need to recalibrate the instrument if you change the range. Make sure the standards for the appropriate range are on hand.

Before using your Turb PLUS 2000, you will need to familiarize yourself with the instrument's operating modes and functions and perform some setup, configuration, and calibration.

- The Turb PLUS 2000 allows for the measurement of the turbidity of process water on-line. The turbidity of the process water is usually reported in **Nephelometric Turbidity Units (NTU)** but may be reported in **Formazine Nephelometric Units (FNU)**.
- Readings above 100 NTU are outside the pre-configured range of this instrument. Readings above 110 NTU will cause the display to flash indicating an over-range condition.
- For a unit calibrated in the 0-10 NTU Range... Readings above 10 NTU are outside range of this instrument. Readings above 11 NTU will cause the display to flash indicating an over-range condition.
- For a unit calibrated in the 0-1000 NTU Range... Readings above 1000 NTU are outside the range of this instrument. Readings above 1100 NTU will cause the display to flash indicating an over-range condition.
- During normal operation, the instrument will have the arrow beside **AUTO** highlighted with the current scale displayed on the lower row of the display and the measured reading on the upper row of the display (see illustration below).



## 6.1 Modes of Operation

There are four modes of operation, **AUTO**, **CAL**, **CONFIG** & **HOLD**. To change between AUTO, CAL, HOLD, and CONFIG use the ▲ and ▼ then the ↵ button to select.

**AUTO** mode is the normal automatic operation. This is the default mode when power is applied or restored. The other three modes of operation are limited to 15 minutes with no key presses after which they will return to AUTO mode operation.

**CAL** is the calibration mode. All reading outputs and alarms are held while in this mode of operation. The instrument was calibrated and tested prior to leaving the factory. Therefore, it is possible to use the instrument directly out of the box. Under normal conditions, re-calibration is required once every three months. Quarterly calibration ensures performance within accuracy specifications.

Relay contacts and the 4-20mA will be frozen (held at the current state) while the instrument is in the calibration mode

While in the calibration mode, the instrument has a time-out feature that automatically returns the system operation to the **AUTO** mode after a fifteen (15) minute period of inactivity.

1. Enter the **CAL** mode of the instrument by pressing the ▲ or ▼ buttons until the arrow beside **CAL** is illuminated, then press the ↵ button.
2. Use the ▲ and ▼ buttons to move forward and backward through the calibration points.
3. To exit the **CAL** mode start a calibration point after the countdown starts press ▲ or ▼. When the screen shows ABRT press the ↵ button.

**CONFIG** is the configuration mode. In CONFIG mode, you can customize the instrument according to needs and preferred operation at any time during normal operation. The **CONFIG** mode has been split into sub-menus to facilitate instrument configuration. This is also where logged files and calibration logs can be downloaded and where new software, when available, can be uploaded.

All reading outputs and alarms are held while in this mode of operation. Relay contacts and the 4-20mA will be frozen (held at the current state) while the instrument is in the configuration mode. While in the configuration mode, the instrument has a time-out feature that automatically returns the system operation to the **AUTO** mode after a fifteen (15) minute period.

1. Enter the **CONFIG** mode of the instrument by pressing the ▲ or ▼ buttons until the arrow beside **CONFIG** is illuminated, then press the ↵ button.
2. To exit the **CONFIG** mode at any time, press the ↵ button.
3. The ◀ and ▶ buttons are used to move forward and backward through the menus.

Shown below is a Flow Chart depicting the options under the configuration operation.

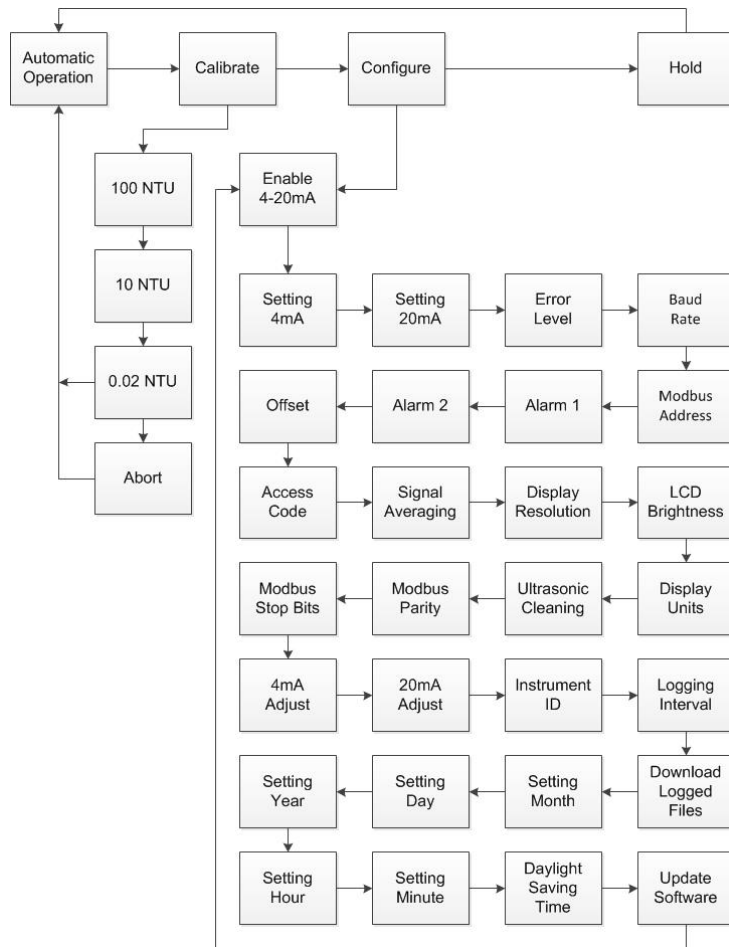

Figure 7: Turb PLUS 2000 Flow Chart



**HOLD** mode is intended for servicing the instrument and holds the outputs and alarms. During this mode, the 4-20mA and alarms are frozen. This mode can be used to ensure that no changes accidentally are made to the instrument. This mode will time out after 15 minutes and revert back to AUTO mode.

The **HOLD** mode can be used during any maintenance functions such as changing the cuvette or desiccant without affecting alarms or the 4-20mA output signals.

1. Enter the **HOLD** mode of the instrument by pressing the ▲ or ▼ buttons until the arrow beside **HOLD** is illuminated, then press the ↵ button.
2. Once selected the letters above will change from OFF to ON.



**CAL, CONFIG & HOLD** are limited to 15 minutes after which time they automatically revert to **AUTO** mode.

## 6.2 Configuring the Turb PLUS 2000

The Turb PLUS 2000 has been designed to provide the ability to customize the instrument according to needs at any time during normal operation. The **CONFIG** mode has been split into sub-menus to facilitate instrument configuration. This section describes how to use each of the sub-menus to configure the instrument. In the sections below each sub-menu under the **CONFIG** mode is discussed in the order that they are reached by circling through the CONFIG mode, as identified in the flow chart located previously.

After confirming that the Turb PLUS 2000 is safely and properly mounted, connected and installed, turn the instrument ON by connecting or turning on the power.

To enter the **CONFIG** Mode:

1. Press the ▲ or ▼ buttons until the arrow beside **CONFIG** is illuminated.
2. Then press the ↵ button.

To exit the **CONFIG** Mode:

1. Press the ↵ button.
2. Use the ◀ and ▶ buttons to move forward and backward through the menus.

### 6.2.1 Configuring the 4-20mA Output



The 4mA can be set higher than the 20mA level to invert the output current is required. This may be required to control a dosing pump.

See 6.2.13 to calibrate the 4-20mA output.

To enable or disable 4-20mA output:

1. Enter the **CONFIG** mode by pressing the ▲ and ▼ buttons until the arrow beside **CONFIG** is displayed.
2. Then press the ← button. The next three menus appear only if the 4-20mA is enabled. If disabled skip down to 4.2.2
3. This will be the first menu shown unless the options flow switch was ordered. Use the ▲ or ▼ buttons to select whether the 4-20mA will be **On** or **OFF**.
4. Press the ► button to accept the setting and move to the next menu or the ← button to exit and return to **AUTO**.



To set the 4-20mA:

1. The first prompt will be the turbidity limit assigned to the 4mA output level. Select the turbidity level to assign to the **4mA** using the ▲ and ▼ buttons. The factory setting is 0.02 NTU.



2. Next, select the turbidity level to assign to the **20mA** output level using the ▲ and ▼ buttons. The factory setting is 100.00 NTU.

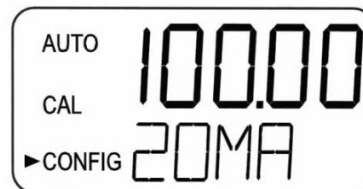

3. **20MA** is displayed on the lower row of the LCD display. Select the turbidity level to assign to the 20MA using the ▲ and ▼ buttons.
4. Once the desired level has been set, press the ► button to accept the setting and move to the next menu or the ← button to exit and return to **AUTO**.

### Error Level - Configuring the Error Level

In case of an error in the Turb PLUS 2000, the 4-20 mA reading can be used to indicate a problem by sending the current to either **4.00** mA, **2.00** mA, **0.00** mA, or **OFF**.



The factory default setting is **OFF** and the 4-20mA is unaffected by any error condition.

To change the Error Level:

1. Enter the **CONFIG** mode by pressing the ▲ and ▼ buttons until the arrow beside **CONFIG** is illuminated, then press the ↵ button.
2. Press the ▶ button to move to the next menu until **ERLV** is displayed.
3. Select the desired **ERLV** by using the ▲ and ▼ buttons then press the ▶ button to accept the setting and move to the next menu or the ↵ button to exit and return to **AUTO**.

### 6.2.2 Baud Rate - Selecting the RS-485 Baud Rate

The baud rate can be selected for the operation of the I/O port. Available baud rates are: 1200, 2400, 4800, 9600, or 19200.

To change the Baud Rate:

1. Enter the **CONFIG** mode by pressing the ▲ and ▼ buttons until the arrow beside **CONFIG** is illuminated, then press the ↵ button.
2. Press the ▶ button to move to the next menu until **BAUD** is displayed.
3. Select the desired **BAUD** rate by pressing the ▲ or ▼ buttons to change the displayed baud rate.

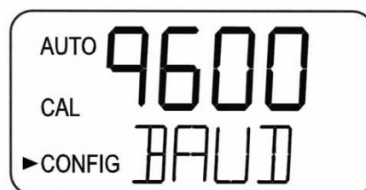

4. Press the ▶ button to accept the setting and move to the next menu or the ↵ button to exit and return to **AUTO**.

### 6.2.3 Modbus Address – Address Selection

The Modbus address of the Tub PLUS 2000 can be set from 1 to 255.

To change the Modbus Address:

1. Enter the **CONFIG** mode by pressing the ▲ and ▼ buttons until the arrow beside **CONFIG** is illuminated, then press the ↵ button.
2. Press the ▶ button to move to the next menu until **ADDR** is displayed.
3. Select the address using ▲ or ▼ buttons.



4. Press the ▶ button to accept the setting and move to the next menu or the ↵ button to exit and return to **AUTO**.

### 6.2.4 Configuring the Alarms

Two relays are provided that are designed to operate as two independent programmable alarms. Three types of information must be input to fully program each alarm:

- The alarm function (**HI**, **LO**, **OFF** or **Error**)
- The alarm set point (the level at which the alarm activates)
- The delay time for the alarm: The time that the setpoint must be exceeded prior to an alarm activation and the time before resetting the alarm (prevents chatter in the relay).

**Alarm Function:** The alarms can either be turned **OFF** or programmed to operate in one of three different manners:

- **HI** alarm: the relay changes state when the measured turbidity level is higher than the programmed alarm level for a prescribed time.
- **LO** alarm: the relay changes state when the measured turbidity level is lower than the programmed alarm level for a prescribed time.
- **Error**: the relay changes state when a system error occurs. If a system error occurs a message will appear on the lower row of the screen describing the problem.

**Alarm Set Point:** The level at which an alarm activates is called the alarm set point. On the instrument, the alarm set point is designated as "**S/P**". The setpoint is adjustable to any valid turbidity level over the range of the instrument in steps of 0.01 NTU.

**Alarm Delay Time:** The alarm delay times are used to prevent tripping the alarm when the turbidity level is close to the setpoint. The function of the delay times is as follows:

- **Delay On:** The turbidity level must exceed the alarm set point continuously for at least this number of seconds before the alarm activates.
  - If the “delay on” time is set at 5 seconds and the process turbidity exceeds the set point continuously for only 4 seconds, the alarm will not be activated. However, if process turbidity exceeds the set point continuously for 5 seconds or more; the instrument will activate the alarm.
- **Delay Off:** The turbidity level must not exceed the alarm set point continuously for at least this number of seconds prior to deactivation of the alarm.
  - If the “delay off” time is set to 5 seconds and the process has exited out of the alarm condition, the alarm will be reset only if the process is out of the alarm condition for a continuous 5 seconds. Otherwise, the instrument will still signal an alarm condition.

#### 6.2.4.1 Alarm 1 - Configuring Alarm 1

Alarm 1 Function: The **ALM1** is displayed and the display indicates the current function of Alarm 1 (**HI**, **LO**, **OFF** or **Error**).

1. Use the ▲ or ▼ buttons to cycle through and select the desired function.
2. Press the ► button to accept it and move to the next menu.
3. If the alarm was turned **OFF** a prompt will appear to set up Alarm 2 (go to section 4.2.10.2). If, on the other hand, one of the other **HI** or **LO** was selected, a prompt will appear to set the delay times.

**Alarm 1 Set Point:** Setpoint is indicated by “**S/P**” shown on the lower row of the display, and is used to select the set point for this alarm.

1. Select the desired alarm level by using the ▲ and ▼ buttons.



2. Once the desired set point has been set, press the ► button to accept it and move to the next menu.

### Alarm 1 Delay Times

Delay On: The following display will appear to allow you to select the number of seconds currently set for the “delay on” time. The currently selected number of seconds will be shown.

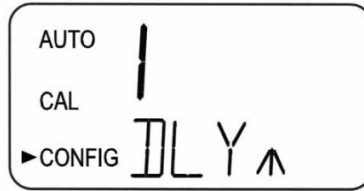

1. Select the desired number of seconds for the “delay on” time for this alarm using the ▲ and ▼ buttons.
2. Once the desired delay time has been set, press the ► button to accept it and move to the next menu.

### Delay Off

Next, the following display will appear to select the number of seconds currently set for the “delay

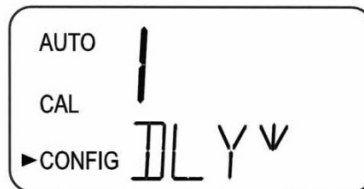

off” time. The currently selected number of seconds will be shown.

1. Select the desired delay off time for this alarm using the ▲ and ▼ buttons.
2. Once the desired delay time has been set, press the ► button to accept it and move to the next menu.
3. After the settings for Alarm 1 have been completed, prompts will allow for the set-up of the information on Alarm 2.

### 6.2.4.2 Alarm 2 - Configuring Alarm 2

Repeat the procedure listed in section 4.2.4.1 to set up the parameters for Alarm 2.

### 6.2.5 Offset – Offset Reading Adjustment

A reading offset can be made to allow for the Turb PLUS 2000 to agree with another instrument if desired. This range is limited to  $\pm 1$ NTU. For more information see section 6.3.6.

To change the Offset:

1. Enter the **CONFIG** mode by pressing the ▲ and ▼ buttons until the arrow beside **CONFIG** is illuminated, then press the ↵ button.
2. Press the ▶ button to move to the next menu until **OFST** is displayed.
3. Select the offset using the ▲ or ▼ buttons to turn the function **On**. When the OFST is turned ON it will stay illuminated in **AUTO** as a reminder that it is being used.
4. Select the offset using the ▲ or ▼ buttons.
5. Press the ▶ button to accept the setting and move to the next menu or the ↵ button to exit and return to **AUTO**.

### 6.2.6 Access Code - Setting Security

The Turb PLUS 2000 is equipped with a security access feature that can be activated. If this option is turned ON, the user is required to input an access code into the instrument to get to any mode other than **AUTO**. A three-digit code is used. When the **CODE** is turned **On** the icon will be illuminated in **AUTO** as a reminder that an access code is being used.



Xylem Analytics Germany highly recommends the use of a security access code in order to help prevent unauthorized access to the system and data.

To set the Security to on/off:

1. Enter the **CONFIG** mode by pressing the ▲ and ▼ buttons until the arrow beside **CONFIG** is illuminated, then press the ↵ button.
2. Press the ▶ button to move to the next menu until **CODE** is displayed.
3. Use the ▲ or ▼ buttons to select the setting. (**On** or **OFF**).

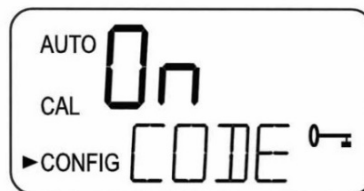

To set the security code:

1. With the security feature enabled ("ON"), press the ► button. The screen shown in the illustration below will appear:

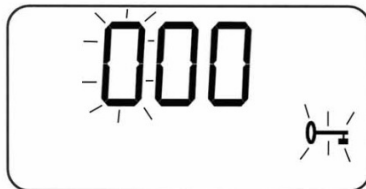

2. The 3 digit security code is set one digit at a time. Using the ▲ or ▼ buttons, select each digit. The flashing digit is the number that is currently being adjusted.
3. Once a digit is selected, press the ► button to move on to the next number.
4. Now enter the second number in the code. Proceed as with the first number followed by ►.
5. Repeat the process for the third, and finish with the ► button.



When the code is turned On, the code must be used to exit AUTO.

6. If a valid access code has been selected, the instrument will be directed to the calibration mode. If the wrong access code is selected, the instrument will return to the **AUTO** mode.

### 6.2.7 Signal Averaging - Setting Speed of Response

The averaging can be used to smooth out the response to spikes or unstable readings that may be caused by bubbles or small debris. The response is done by averaging readings. Both displayed and output values of NTU are affected in this menu. The default setting is 1; however, up to 60 readings can be averaged. To avoid reading air and other anomalies, select a higher averaging. Select the lowest averaging where monitoring of rapid changes is needed. These are one-second intervals so the maximum averaging is 60 seconds. The factory default is 10.

To change the Averaging:

1. Enter the **CONFIG** mode by pressing the ▲ and ▼ buttons until the arrow beside **CONFIG** is illuminated, then press the ← button.
2. Press the ► button to move to the next menu until **RESP** is displayed.
3. Use the ▲ or ▼ buttons to select the setting for the speed of response desired.

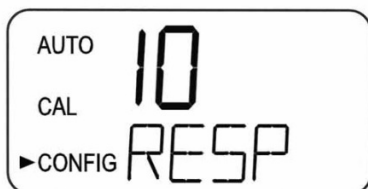

4. Press the ► button to accept the setting and move to the next menu or the ← button to exit and return to **AUTO**.



### 6.2.8 Display Resolution - Setting Resolution

The instrument is equipped with the ability to display several levels of resolution. The instrument can display up to four digits to the right of the decimal place for turbidity readings below 10 NTU. The default setting is 000.00. If the last digit or two is not stable, adjust the resolution to hide these insignificant digits.

To change the Resolution:

1. Enter the **CONFIG** mode by pressing the ▲ or ▼ buttons until the arrow beside **CONFIG** is illuminated, then press the ↵ button.
2. Press the ▶ button to move to the next menu until **RES** is displayed, then press the ↵ button.
3. Change the resolution by pressing the ▲ or ▼ button.
4. When the desired digit resolution has been selected, press the ▶ button to accept it and move to the next menu or the ↵ button to exit and return to **AUTO**.



### 6.2.9 LCD Brightness - Setting the LCD backlight brightness

The LCD backlight brightness may need to be adjusted. This is of particular interest if multiple instruments are located in the same area and it is desired for the entire group to have the same appearance. Ten levels are available. The default brightness is 8.

To adjust Backlight Brightness:

1. Enter the **CONFIG** mode by pressing the ▲ and ▼ buttons until the arrow beside **CONFIG** is illuminated, then press the ↵ button.
2. Press the ▶ button to move to the next menu until **BRT** is displayed.
3. Change the brightness by pressing the ▲ or ▼ button.



4. When the desired brightness has been selected, press the ▶ button to accept it and move to the next menu or the ↵ button to exit and return to **AUTO**.

### 6.2.10 Display Units - Setting Displayed Units

The most common unit is **NTU** (Nephelometric Turbidity Units) however the instrument can display in **FNU** (Formazine Nephelometric Units). All instruments are shipped from the factory set in NTU mode.

To set/change the units:

1. Enter the **CONFIG** mode by pressing the ▲ and ▼ buttons until the arrow beside **CONFIG** is illuminated, then press the ↵ button.
2. Press the ▶ button to move to the next menu until **UNIT** is displayed.
3. Use the ▲ or ▼ buttons to select the setting **NTU** or **FNU**.



4. Press the ▶ button to accept it and move to the next menu or the ↵ button to exit and return to **AUTO**.

### 6.2.11 Ultrasonic Cleaning - Cleaning Function

This allows for a selection menu to turn off the ultrasonic cleaning function if desired. The default mode is **On**.

To set the ultrasonic cleaning to On/Off:

1. Enter the **CONFIG** mode by pressing the ▲ and ▼ buttons until the arrow beside **CONFIG** is illuminated, then press the ↵ button.
2. Press the ▶ button to move to the next menu until **CLN** is displayed.
3. Select **On** or **OFF** using the ▲ and ▼ buttons.



4. Press the ▶ button to accept the setting and move to the next menu or the ↵ button to exit and return to **AUTO**.

### 6.2.12 Modbus Parity & Modbus Stop Bits - RS485 Parameters

These two menus will be used to set the balance of the RS-485 parameters. The default is no Parity (nOnE), 1 Stop Bit.

To set the Modbus Parity:

1. Enter the **CONFIG** mode by pressing the ▲ and ▼ buttons until the arrow beside CONFIG is illuminated, then press the ↵ button.
2. Press the ▶ button to move to the next menu until **PRTY** is displayed.
3. Make selections using the ▲ and ▼ buttons

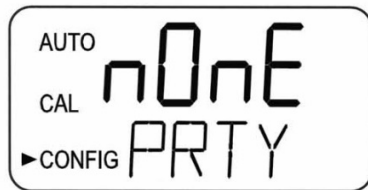

4. Press the ▶ button to accept it and move to the setting STOP.

To set the Modbus stop bits:

1. Enter the **CONFIG** mode by pressing the ▲ and ▼ buttons until the arrow beside **CONFIG** is illuminated, then press the ↵ button.
2. Press the ▶ button to move to the next menu until **STOP** is displayed.
3. Make selections using the ▲ and ▼ buttons
4. Press the ▶ button to accept it and move to the next menu or the ↵ button to exit and return to **AUTO**.

### 6.2.13 4mA and 20mA Adjustment

If the 4-20 mA setting is turned On, two menus will appear one for each 4 and 20mA adjustment.

#### 4mA Adjustment

The first menu outputs a constant 4mA while allowing for a small amount of adjustment. This adjustment will allow the operator to make the Turb PLUS 2000 agree with a PLC or SCADA system. The adjustment limits are  $\pm 200$  counts or about  $\pm 0.2$  mA.

This setting will be slightly different on each instrument as each Turb PLUS 2000 will be factory set to 4.00mA. Press the ▶ button when adjustments are complete to save this setting and move on to the 20mA adjustment.

To set the 4mA Levels:

1. Enter the **CONFIG** mode by pressing the ▲ and ▼ buttons until the arrow beside **CONFIG** is illuminated, then press the ↵ button.
2. Press the ► button to move to the next menu until **4MA** is displayed.
3. Adjust setting using the ▲ and ▼ buttons.



4. Press the ► button when adjustments are complete to save this setting and move on to the 20mA adjustment.

### 20mA Adjustment

This menu operates similarly to the previous menu. This menu outputs a constant 20 mA while allowing for a small amount of adjustment. The adjustment limits are  $\pm 1000$  counts or about  $\pm 1$  mA.

This setting will be slightly different on each instrument as each Turb PLUS 2000 will be factory set to 20.00mA.

1.

To set the 20mA Levels:

1. Enter the **CONFIG** mode by pressing the ▲ and ▼ buttons until the arrow beside **CONFIG** is illuminated, then press the ↵ button.
2. Press the ► button to move to the next menu until **20MA** is displayed.
3. Adjust setting using the ▲ and ▼ buttons.



4. Press the ► button to accept the setting and move to the next menu or the ↵ button to exit and return to **AUTO**.

### 6.2.14 Instrument ID – Instrument Unique Number Identification

This menu provides the instrument with a unique ID up to 4 digits. This ID can be used when logged data is downloaded. This enables the data to be associated with a particular instrument or location.

To set the instrument ID:

1. Enter the **CONFIG** mode by pressing the ▲ and ▼ buttons until the arrow beside **CONFIG** is illuminated, then press the ↵ button.
2. Press the ▶ button to move to the next menu until **ID** is displayed.
3. Use the ▲ and ▼ buttons to select the value of the first number. Use the ▶ to select the next number and repeat the process for all numbers. Scroll through the numbers to the next menu.

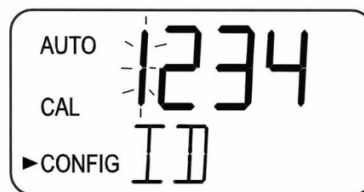

### 6.2.15 Logging Interval – Setting the interval for logged files

This menu determines how often readings are logged. The setting is in minutes. This can be set from 1 minute to 60 minutes.

To set the logging interval:

1. Enter the **CONFIG** mode by pressing the ▲ and ▼ buttons until the arrow beside **CONFIG** is illuminated, then press the ↵ button.
2. Press the ▶ button to move to the next menu until **INVL** is displayed.
3. The value can be adjusted by using the ▲ and ▼ buttons.









4. Once the value is set, press the ▶ button to accept it and move to the next menu or the ↵ button to exit and return to **AUTO**.



### 6.2.16 Download Logged Files – Select to Download

This menu is used to download CSV files to a flash drive. The selections are No download (NO), Calibration file only (CAL), All Files (ALL) or individual month (Jan, Feb...). Once the data stick is inserted into the USB slot on the right side of the instrument push the  button. If no data stick is inserted you will get an Error (Err). See section 7.4.2 File Downloads for more information. The upper display will flash while the download is taking place and show dOnE when complete.

To set the data download:

1. Enter the **CONFIG** mode by pressing the  and  buttons until the arrow beside **CONFIG** is illuminated, then press the  button.
2. Press the  button to move to the next menu until **DOWN** is displayed.
3. The selection can be adjusted by using the  and  buttons.









4. Once the selection is made press the  button to accept it and move to the next menu or the  button to exit and return to **AUTO**.



### 6.2.17 Date and Time – Setting of Instrument Time & Date

The Turb PLUS 2000 has a displayed date (month / day / year) and time (hour / minute / Daylight Savings) that must be set upon initial installation/setup. The next five menus are used for this setup.

To set the Month:

1. Enter the **CONFIG** mode by pressing the  and  buttons until the arrow beside **CONFIG** is illuminated, then press the  button.
2. Press the  button to move to the next menu until **MNTH** is displayed, then press the  button.
3. Change the month by pressing the  or  button.



4. When the desired month has been selected, press the  button to accept it and move to the next menu or the  button to exit and return to **AUTO**.

To set the Day:

1. Enter the **CONFIG** mode by pressing the ▲ and ▼ buttons until the arrow beside **CONFIG** is illuminated, then press the ↵ button.
2. Press the ▶ button to move to the next menu until **DAY** is displayed, then press the ↵ button.
3. Change the day by pressing the ▲ or ▼ button.



4. When the desired day has been selected, press the ▶ button to accept it and move to the next menu or the ↵ button to exit and return to **AUTO**.

To set the Year:

1. Enter the **CONFIG** mode by pressing the ▲ and ▼ buttons until the arrow beside **CONFIG** is illuminated, then press the ↵ button.
2. Press the ▶ button to move to the next menu until **YEAR** is displayed, then press the ↵ button.
3. Change the year by pressing the ▲ or ▼ button.



4. When the desired year has been selected, press the ▶ button to accept it and move to the next menu or the ↵ button to exit and return to **AUTO**.

To set the Hour:

1. Enter the **CONFIG** mode by pressing the ▲ and ▼ buttons until the arrow beside **CONFIG** is illuminated, then press the ↵ button.
2. Press the ▶ button to move to the next menu until **HOUR** is displayed, then press the ↵ button.
3. Change the hour by pressing the ▲ or ▼ button.



4. When the desired hour has been selected, press the ▶ button to accept it and move to the next menu or the ↵ button to exit and return to **AUTO**.

To set the Minute:

1. Enter the **CONFIG** mode by pressing the ▲ and ▼ buttons until the arrow beside **CONFIG** is illuminated, then press the ↵ button.
2. Press the ▶ button to move to the next menu until **MIN** is displayed, then press the ↵ button.
3. Change the minute by pressing the ▲ or ▼ button.



4. When the desired minute has been selected, press the ▶ button to accept it and move to the next menu or the ↵ button to exit and return to **AUTO**.

Daylight Savings Time:

**DST** is valid for use in the USA, Canada, and other countries or locations that follow the US Energy Savings Act of 2005.

1. Enter the **CONFIG** mode by pressing the ▲ and ▼ buttons until the arrow beside **CONFIG** is illuminated, then press the ↵ button.
2. Press the ▶ button to move to the next menu until **DST** is displayed, then press the ↵ button.
3. Change the Daylight Savings Time by pressing the ▲ or ▼ button until **ON** is displayed.



4. Press the ▶ button to accept it and move to the next menu or the ↵ button to exit and return to **AUTO**.



### 6.2.18 Update Software - Install Latest Software or Change Range

The software version can be determined by pressing and holding down the ▲ and ▼ buttons for about 1 second. The first number shown is the version and the second number displayed is the model number. This can be performed anytime during AUTO Mode.

Software updates can only be made if a USB flash drive is installed with a newer version of software than the one currently installed in the Turb PLUS 2000. If either a flash drive is not installed or a newer version of the software is not detected the following screen will appear.



To update the software:

1. Connect a USB flash drive with the newer version of software loaded on it.
2. Enter the **CONFIG** mode by pressing the ▲ and ▼ buttons until the arrow beside **CONFIG** is illuminated, then press the ↵ button.
3. Press the ▶ button to move to the next menu until **UPDT** is displayed, then press the ↵ button.
4. Once a flash drive with valid files are found, select the desired range to update using the ▲ and ▼ buttons. Range changes can be made with either the current or later versions. These other ranges were included on a flash drive included with the instrument when new.

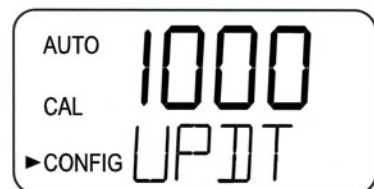
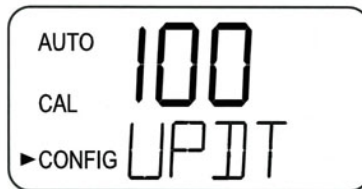
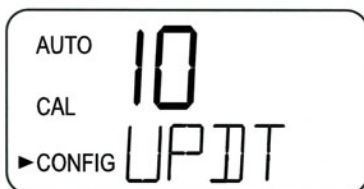

5. Press the ↵ button to start the update.
6. While the system is updating, the word "busy" appears as it performs a self-check of the software installation.



7. If the Turb PLUS 2000 finds a flash drive with a previous version of software it will show the word FILE. You will need an updated file on the flash drive.



- Once installed the system will automatically turn off and restart. The entire process takes up to 90 seconds to complete.



Be certain to check the configuration as changes may have taken place either with new software or a new range.

- You most likely will need to calibrate the instrument. You will see a screen similar that shown below. See the next section to recalibrate the instrument.



### 6.3 Calibrating the Turb PLUS 2000, CAL Mode

The instrument was calibrated for the 0-100 NTU range and tested prior to leaving the factory. Therefore, it is possible to use the instrument directly out of the box. Under normal conditions, recalibration is required once every three months. Quarterly calibration ensures performance within accuracy specifications.



The EPA and ISO recommend that on-line turbidimeters be calibrated with a primary standard at least once every three months if they are to be used for reporting purposes.

Relay contacts and the 4-20mA will be frozen (held at the current state) while the instrument is in the calibration mode. While in the calibration mode, the instrument has a time-out feature that automatically returns the system operation to the **AUTO** mode after a fifteen (15) minute period of inactivity.

### 6.3.1 Calibration Standards (0-100 NTU range)

If the Turb PLUS 2000 will be used over the entire range of .02 to 100 NTU a complete calibration as described below will be required, but you must retain the same calibration schedule as described above. If instrument accuracy is only required below 10 NTU, such as for potable water, a calibration may be performed using only a 10 NTU and a 0.02 NTU standard.

We recommend that the following materials be used during calibration to achieve the full-scale accuracy stated in this manual:

- 100 NTU **ProCal** Calibration Standard available from Xylem Analytics Germany
- 10.0 NTU **ProCal** Calibration Standard available from Xylem Analytics Germany
- 0.02 NTU **ProCal** Calibration Standard available from Xylem Analytics Germany

#### 6.3.1.1 Alternate Ranges



If the range is changed from the factory setting of 0-100 NTU the instrument must be recalibrated.

The calibration values will be 10 NTU, 1 NTU and .02 NTU for 0-10 NTU range. The instrument will prompt for the appropriate standards.

The calibration values will be 1000 NTU, 10 NTU and .02 NTU for 0-1000 NTU range. The instrument will prompt for the appropriate standards.

Calibration kits are available for the optional ranges.

Make changes as needed to the instructions in section 4.3.3 below.



It is well known that diluted Formazine is unstable. If Formazine is used to calibrate the instrument, ensure that a fresh stock suspension of Formazine is used to achieve the accuracy quoted for the instrument.

The WTW primary calibration standards are more stable than Formazine and have a minimum shelf life of 12 months. Prior to recalibration, review the expiration dates, to ensure that the standards have not expired.

### 6.3.2 Indexing Calibration Cuvettes

To achieve the greatest accuracy, and account for normal scratches and aberrations in cuvette glass when calibrating, Xylem Analytics Germany recommends indexing the cuvettes.

Standards and standard kits purchased from Xylem Analytics Germany are supplied with indexing rings. Complete instructions regarding how to index the cuvettes are included in the calibration kits.

The following steps allow repeatable indexing of calibration standards:

1. With the instrument operating in AUTO mode insert the standard into the optical well.
2. Slowly rotate the standard, inside the optical well, one complete revolution (360°). While rotating the standard slowly, observe the measured turbidity and locate the position of the cuvette having the lowest reading.
3. With the calibration standard positioned at the location having the lowest turbidity reading, install the Indexing Ring over the cap on the standard so that the pointer of the Indexing Ring faces directly forward.



When using the standards in the future, always insert the standard so that the pointer of the indexing ring faces forward. Slowly rotate the standard back and forth about 5° to find the lowest point. The standard is now indexed and ready for use.



### 6.3.3 Calibration Procedures

#### NOTICE

**It is recommended that the measurement chamber is kept covered during the calibration period and that the flow through cuvette is replaced immediately after the calibration to prevent premature saturation of the desiccant.**



The 0-100 NTU range will be described below. If another range is selected the Turb PLUS 2000 will prompt for appropriate standards during calibration.

1. Select the calibration function of the instrument by pressing the  button once. The arrow beside **CAL** will be illuminated on the display. The lower display shows alternating **100** (the value of the standard that is requested) and . The upper display shows the real-time reading to allow the standard to be indexed. See section 6.3.2 for information on indexing cuvettes.

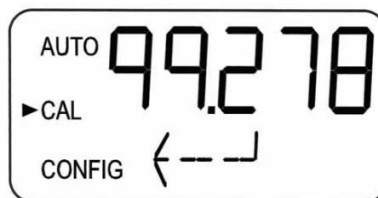
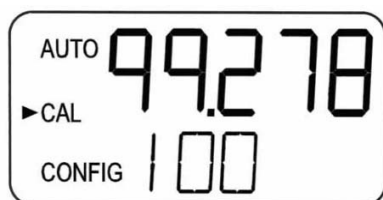

2. Remove the flow through unit.
3. Insert the requested 100 NTU standard. Index the standard to the lowest value on the upper display.

4. To calibrate for 10 NTU and below only, press the ▼ button to bypass the 100 NTU and proceed to step 7.
5. Press the ↵ button to initialize the calibration.
6. The lower display will count down from 30.
7. When complete, the lower display will now change to show alternating 10 and ↵, requesting the 10.0 NTU standard.

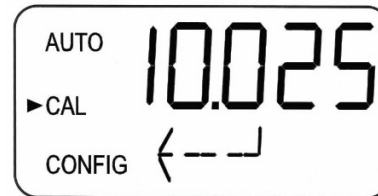
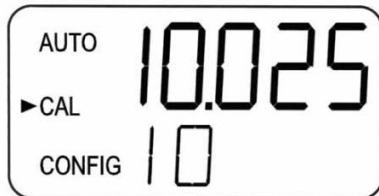

8. If the alternating 10 and ↵ is not displayed, push the ▼ until this display is shown.
9. Insert the requested 10.0 NTU standard. Index the standard to the lowest value on the upper display.
10. Press the ↵ button to initialize the calibration.
11. The lower display will count down from 60.
12. When complete, the lower display will now change to show alternating 02 and ↵, requesting the 0.02 NTU standard.

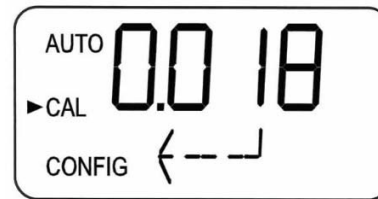
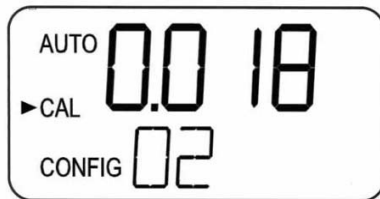

13. Insert the requested 0.02 NTU standard. Index the standard to the lowest value on the upper display.
14. Press the ↵ button to initialize the calibration.
15. The lower display will count down from 30.
16. When complete the instrument will show CAL Good. Press the ↵ button to accept. The display will briefly show STRT and then go to AUTO.



#### 6.3.4 Abort Calibration

If at any time during the calibration process, you can abort the calibration by pushing the ▼ until the screen displays **ABRT** then press the ↵ button. The instrument returns to **AUTO** operation.

The instrument will save and use any points that were calibrated successfully. It should be noted

that the calibration log will report any missed calibration values or failed calibrations.

### 6.3.5 Calibration Failure

The Turb PLUS 2000 will test the validity of the calibration and only good calibrations will be saved for use.

If the calibration fails the message below will show. Press the  button to accept. The instrument will revert to the last valid calibration. Check the standards and recalibrate if desired. The failed calibration will be discarded, however, a record of a failed calibration with the time and date is stored.

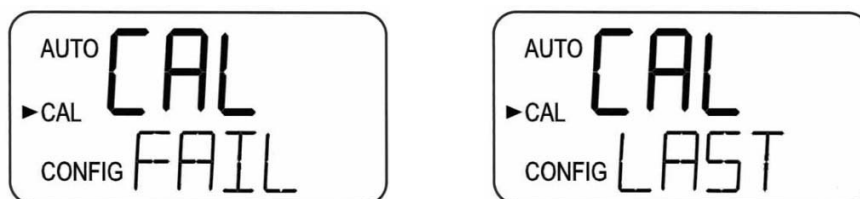

### 6.3.6 Instrument Offset



It is possible to use an offset factor in the instrument rather than performing a physical calibration. This procedure is not recommended in lieu of regular instrument calibration but it can be used to make the Turb PLUS 2000 agree with another instrument.

This calibration technique will make the instrument accurate **only** at turbidity levels in the immediate vicinity of the grab sample and **not** in the full range of the instrument.

Note that the **OFFSET** icon will be illuminated whenever an offset is used. The maximum offset is  $\pm 1.00$  NTU. If the instrument variation is greater than 1 NTU a full calibration is recommended.

See section 6.2.5 for more information on changing the offset.

Below is the offset procedure:

1. Collect a grab sample of the process water that is being monitored by the Turb PLUS 2000 and record the turbidity reported by the instrument.
2. Take the grab sample and measure its turbidity using a laboratory turbidimeter (contact the Xylem Analytics Germany for examples of laboratory turbidimeters).
3. Compare the turbidity reported by the Turb PLUS 2000 to that obtained in the laboratory. If the readings are very close, then no offset adjustment or calibration is required and the procedure may be stopped at this step. However, if the readings are substantially different (but less than 1 NTU), continue on in this procedure to utilize the offset option to improve the turbidity reading of the Turb PLUS 2000 so that it will agree with the laboratory reading between calibrations.
4. Select the offset function of the Turb PLUS 2000 by pressing the  button until the arrow beside **CONFIG** is illuminated on the display then press the  button.
5. Push the  button until **OFST** is displayed on the lower row.

- The upper row of the display will indicate the operational status of the offset function (**On** or **OFF**). Change this status to **On** by using the ▲ and ▼ buttons. Then press the ► button to accept it and move to the adjustment menu
- This will add or subtract the value of the offset to the measured NTU value. As an example if the Turb PLUS 2000 measures the process at 0.36 NTU but the laboratory instrument read the sample at 0.12 NTU, adding an offset of  $-0.24$  would result in the Turb PLUS 2000 displaying 0.12 NTU.
- Select the desired offset level using the ▲ and ▼ buttons. Once the desired level has been set, press the ↵ button to accept it.
- This completes the offset configuration
- The instrument will return to the **AUTO** mode with the offset mathematically added to the reading.



## 7.0 Operation

### NOTICE

Prior to use for the first time, the supplied desiccant pouch will need to be installed.

### 7.1 Installing or Replacing the Desiccant Pouch

The Turb PLUS 2000 continuously checks the condition of the desiccant. When the desiccant gets in such a condition that it may cause problems, the instrument will display **DESC** on the lower portion of the display to indicate the presence of humidity.

Proper use of the supplied desiccant is essential in maintaining the performance of the instrument. The desiccant has been designed to have a long life; however, replacement of the desiccant pouch will be required from time to time.

It is essential that the enclosure seal on the instrument base be maintained to ensure adequate desiccant life. Inspect the seal each time the desiccant pouch is replaced. Replace or reseal the seal if it is found to be defective.

The desiccant should be replaced when the instrument displays **DESC**. A new, sealed desiccant pouch and indicator card are available from Xylem Analytics Germany.

- To initially install or remove the old desiccant, simply unscrew the four corner thumbscrews and remove the electronics half of the instrument.
- If replacing an old desiccant pouch, remove the used desiccant pouch from the instrument.
- Open the bag protecting the new desiccant pouch.
- Insert the new desiccant pouch in the instrument base assembly.

- To speed up the recognition, of the new desiccant, by the instrument, it may be necessary to reset the instrument by disconnecting the sensor interconnect cable for 2 seconds and then reconnecting it.

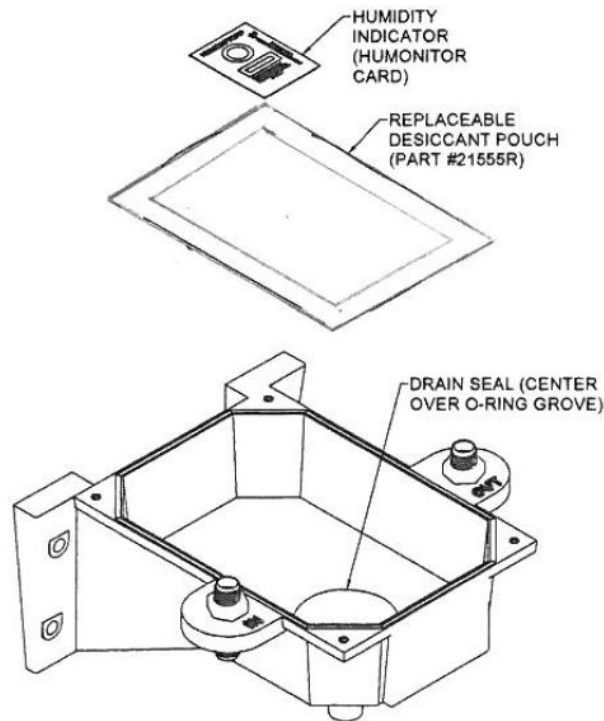

Figure 8: Installing the Desiccant

#### NOTICE

Once the bag is opened, install the desiccant pouch immediately to prevent premature degradation of the desiccant.

## 7.2 Starting the System

The following steps describe how to measure the turbidity of a sample using this instrument:

- Apply power to the instrument and allow the unit to warm up (typically 45 minutes – 1 hour on initial commissioning).
- Check the cuvette to make sure it is tight before starting the flow. The cuvette should be handled at the top 1/2" to prevent fingerprints from interfering with readings.
- After the initial warm-up period and once a continuous process stream is flowing through the instrument, the instrument will display the measured turbidity level of the sample by displaying it on the LCD screen. In addition, the equivalent signal is provided on the analog (4-20 mA) output, or the digital output, depending on the options selected.
- Initial settings like Date and Time (see section 6.2.17) must be set now.





### 7.3 Routine Measurement: AUTO Mode

After the instrument has warmed up and the instrument is operating in AUTO mode, readings will be updated (posted) once per second. These updates occur to the screen, Modbus, 4-20mA and can be logged internally to the instrument. These updates also affect the operation of the alarms. Please note that these updates are all affected by the setting of the Signal Averaging (see section 6.2.7) and possibly Offset (see section 6.2.5).

If power is lost at any time, once power is restored, the instrument will restart and the instrument will continue in AUTO operation with the same settings. There may be some slight instability if the instrument cooled off. If the onboard data logging was used it will record 0.00NTU during the period that instrument is not running.



The Turb PLUS 2000 can read up to 110% of the range. Readings above 100% of the range may not be accurate. After 110% of that range the display will flash indicating an over-range condition. The 10 NTU range can display up to 11 NTU, the 100 NTU range can display up to 110 NTU, and the 1000 NTU range can display up to 1100 NTU.

### 7.4 Data Retrieval

Data is available in several forms. It can be viewed on the screen, logged in the instrument, read via Modbus or output the 4-20 mA.

#### 7.4.1 USB Connection

The USB connection can be used to upload new software or download logged data and calibration reports via a USB flash drive.

Software uploads can be made by loading the software onto a USB flash drive and inserting it into the USB connector. The update will not affect configurations or stored data, however it always advisable to check the configuration as menus may change. The instructions are in section 6.2.18 of this manual.

#### 7.4.2 File Downloads

All files download in a CSV (comma separated value) file format. These are easily imported directly into most spreadsheet and database programs. The main data includes the Date, Time, Reading, Units, Alarm 1 and Alarm 2. The instrument ID is part of the file name. For more information on downloading data logged files, see 4.2.16

Some sample data is shown below.

Date	Time	Reading	Units	Alarm 1	Alarm 2
6/9/2017	16:01	0.024	NTU	Off	Off
6/9/2017	17:02	0.023	NTU	Off	Off
6/9/2017	17:03	0.022	NTU	Off	Off
6/9/2017	17:04	0.022	NTU	Off	Off

Date	Time	Reading	Units	Alarm 1	Alarm 2
6/9/2017	17:05	0.02	NTU	Off	Off
6/9/2017	17:06	0.02	FNU	Off	Off
6/9/2017	17:07	0.022	FNU	Off	Off

The file structure of the logged data will be in Year/Month/Day. At midnight of each day the current day's file is closed and a new day's file is opened.

#### NOTICE

**For moisture tightness and humidity control, the supplied USB plug cover must be kept installed firmly when not being used. Failure to correctly install the plug will affect desiccant life.**



### 7.4.3 Modbus Communication

Modbus protocol communication is operational on all models.

### 7.5 Patented Ultrasonic Cleaning 1

This feature is used to continuously clean the flow through the cuvette. It is not intended to clean cuvettes that are already dirty or replace manual cleaning entirely. See section 7.7 for instructions on cuvette cleaning.

The system will increase the time between cleanings dramatically. Please note that the system requires the use of a special cuvette which is included with the instrument. This cuvette must be used for the system to operate correctly.

The system works by sending an ultrasonic frequency through spring connections into a piezo transducer bonded to the bottom of a flow-through cuvette (see figure 10).

The system can detect that an incorrect cuvette is installed, an error has occurred in the transducer or the transducer is not making contact with the spring connections. This error is indicated by **CLN** being posted to the lower screen. Since this is an error condition, this may affect the 4-20 mA and alarms depending on the setting of the ERLV (4-20 mA) and if an alarm is set up to Error.

---

<sup>1</sup> U.S. Patent No. 7,808,642

If the correct cuvette is installed, and the error is still posted, try rotating the flow through assembly slightly to improve the connection to the ultrasonic transducer. If this fails to work, the cuvette may have to be replaced. The detection for this cuvette only operates in **AUTO** mode. If the system is operating correctly **AUTO** will flash on the display.

The connection can be improved with the use of a small film of an anti-oxidant compound such as OX-GARD™ made by GB Electrical Inc. This product is available in the electrical section at most hardware stores.

## 7.6 Condensation on Cuvette

The Vapor Purge system prevents moisture, due to condensation, from occurring inside the instrument. To ensure proper performance, the desiccant and seals must be maintained in good condition. If these are distorted or worn they need to be replaced.

Once the flow through is removed from the instrument, it is possible to have condensate form on the cuvette. It is not desirable to bring additional moisture into the instrument as this will lower the desiccant life. For this reason, any condensate should be wiped from the cuvette before reinstalling the flow through unit.

If condensate forms on the cuvette, use the following procedure:

1. Shut off the flow with the provided ratcheting clamp.
2. Empty the water out of the cuvette to lower the cold mass.
3. If clean warm water is available it can be poured into the cuvette.
4. Dry and clean the exterior of the cuvette.
5. Ensure the cuvette is installed into the flow through tightly.
6. Reinstall the flow through unit.
7. Restart the sample water flow.

Once the flow through assembly is inserted into the instrument, the Vapor Purge system will prevent further condensate from forming inside of the instrument no matter the outside environment or the temperature of the sample water.

All seals are important for proper operation and to extend desiccant life. These seals must be in place and maintained. Replace any missing or distorted seals or worn call Xylem Analytics Germany (section 6.4) Three important seals that are often overlooked are the O-ring under the flow head, the orange enclosure seal, and the USB plug cover.

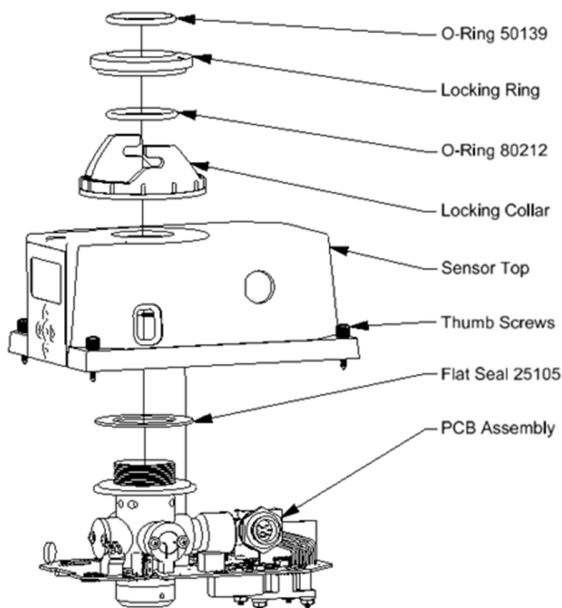

Figure 9: Instrument Seals

**NOTICE**

The cuvette must be completely dry before it is inserted into the sensor. If there is any visible moisture present on the cuvette or transducer, there is a great risk of damaging the sensor electronics and the transducer. Be sure to clean and dry the cuvette completely just before inserting it into the sensor.

The Vapor Purge system can NOT remove large droplets of water, only residual moisture.

**NOTICE**

For the Vapor Purge system to function properly, all instrument seals must be maintained and the desiccant pack must be in good condition (no DESC display).

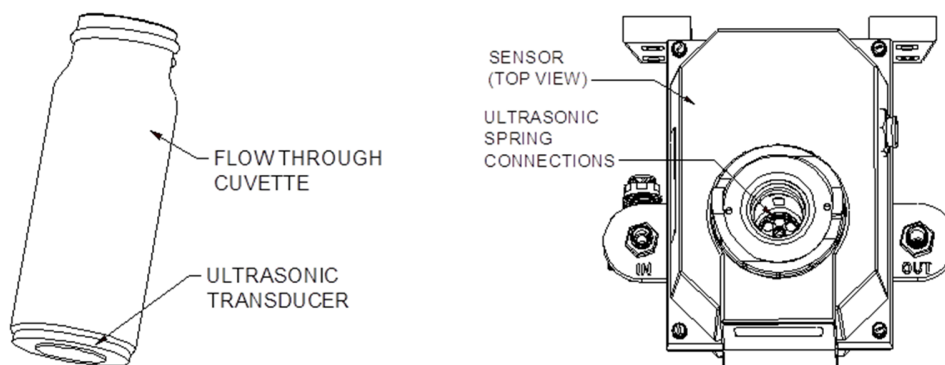

Figure 10: Operational Parts of the Ultrasonic Cleaning System



Certain routine maintenance items, such as calibration and desiccant change, are triggered by internal diagnostic alerts. The time to take other routine maintenance tasks, such as removal of flow through to manually clean cuvette, will vary based on system usage and water quality conditions.

## 7.7 Cleaning the Flow-Through Cuvette

Measurement cuvettes used for both the grab sample and the flow through should be clean and free of marks or scratches. It is recommended to check, and if required clean, the cuvette every three months when performing the primary calibration. The flow-through assembly must be removed to perform the calibration procedure.

Cleaning is accomplished by cleaning the interior and exterior with a detergent solution and then rinsing several times with distilled or de-ionized water.

The cuvette can be replaced by first shutting off the flow using the provided shutoff clamp; unscrewing the old cuvette and replacing with a fresh clean one.

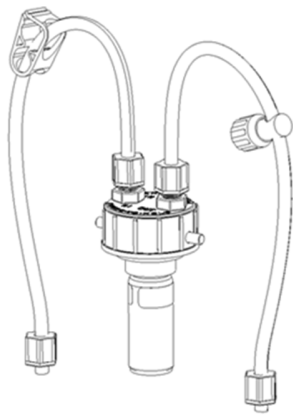

Figure 11: Flow-Through Assembly

## 7.8 Replacing the Source Lamp

The source lamps in the Turb PLUS 2000 instruments are designed for long life. The IR lamp and white light version have long lives. These lamps, however, are not covered by the warranty. If the lamp should need replacement, we recommend calling Xylem Analytics Germany for assistance.

## 7.9 Optional Factory Installed 24V Option

This factory installed option allows for the operation of the Turb PLUS 2000 from 24 volts DC. For this instrument, the changes are in the junction box only.

The range of correct operation is from 18-36VDC. Caution must be used to not exceed this voltage.

Connections are not polarity sensitive and are made to the same place as mentioned in section 3.4.1.

All other specifications remain unchanged.

## 8.0 Troubleshooting

### 8.1 Turb PLUS 2000 Fault Detection

The Turb PLUS 2000 performs continuous diagnostic monitoring. In the Turb PLUS 2000 there are three levels of fault detection:

- Warnings
- Errors
- Failures

Any faults are displayed in a queue form in the bottom row of the LCD. How these faults are indicated depends on the settings made in sections 4.2.1 *Configuring the Error Level* and 4.2.4 *Configuring the Alarms*.

If ERLV is set to OFF and Alarms are not set to Error, there will be no remote indication of a problem.

#### 8.1.1 Warnings

If the desiccant becomes saturated, only a screen **warning** of **DESC** will appear and but alarms will be activated. Other warnings are **ALM1** or **ALM2** will be displayed if an alarm is set and the threshold is exceeded.

#### 8.1.2 Errors

An **error** indicates a failure or a problem that usually can be corrected by the operator. These errors consist of:

- **LAMP** - Lamp out
- **MA** - 4-20 mA loop open
- **FLOW** - If option equipped, enabled and no flow
- **CLN** - Turb PLUS 2000 is equipped with ultrasonic cleaning and message will indicate that the ultrasonic transducer is not making contact or the flow through has been removed

If any of these errors occur DO NOT rely on displayed readings. These errors affect accuracy and reliability of instruments readings.

#### 8.1.3 Failures

A **failure** is a system fault. This is NOT a problem that the operator can correct, and the unit must be returned to the factory for service. These failures consist of failures in the CPU, A/D, EEPROM or other devices internal to the instrument. The word **FAIL** will display on the lower row.

## 8.2 Diagnostic Table

Symptom	Cause	Cure
Lower display shows <b>MA</b>	4-20 mA loop open	Check wiring. See sections 5.4.2 and 6.2.1
Lower display shows <b>DESC</b>	Desiccant pouch bad	Change desiccant pouch. See section 7.1
Lower display shows <b>LAMP</b>	Lamp failed	Replace lamp. See section 7.8
Lower display shows <b>FLOW</b>	Flow option error Sample flow has stopped	Restore flow. Contact HF about factory installed option
Lower display shows <b>FAIL</b>	Major system fault	See section 8.1.3
Lower display shows <b>CLN</b>	Ultrasonic cuvette not found	Either turn off the CLN in CONFIG or check/replace the ultrasonic cuvette. See Sections 6.2.11 & 7.5
Upper display shows <b>FILE</b>	Update not possible because new file not found	Check USB flash drive. See section 6.2.18
Readings are higher than expected	Bubbles in solution  Condensate or leaky cuvette  Flow through cuvette dirty  Instrument out of calibration	Apply backpressure. See section 8.3 and figure 4.  For severe cases of bubbles, a stilling chamber is available. Call Xylem Analytics Germany.  Check flow-through cuvette for condensate or leaks. Change desiccant if needed.  Clean cuvette. See section 7.7  Recalibrate. See section 6.3
Readings are erratic	Bubbles in solution Debris in flow through	See above Clean debris from cuvette
Readings are lower than expected	Instrument out of calibration	Recalibrate. See section 6.3
Upper display flashes	Sample Over-Range	Check sample. Sample may be too high to read.

## 8.3 Bubbles in the Sample

If bubbles are present in the sample water the readings may appear higher than expected. These reading may also not be stable.

Remove cuvette if air can be seen coming into the flow-through unit from the inlet tube, this is air introduced, probably from a small water or air leak. This will need to be resolved in the plumbing.

If air cannot be seen entering the intake tube but appears on the inside of the glass cuvette, it is coming out of solution. This can usually be cured by applying pressure to the rotary backpressure

clamp on the OUT side of the cuvette. This helps keep the air in solution so it will not be seen by the instrument. See figure figure 4.

## **8.4 Technical and Customer Assistance**

If for any reason assistance is needed regarding this instrument please do not hesitate to contact Xylem Analytics Germany.



# MOUNTING TEMPLATE

ALL DIMENSIONS ARE IN MILLIMETERS (INCHES)

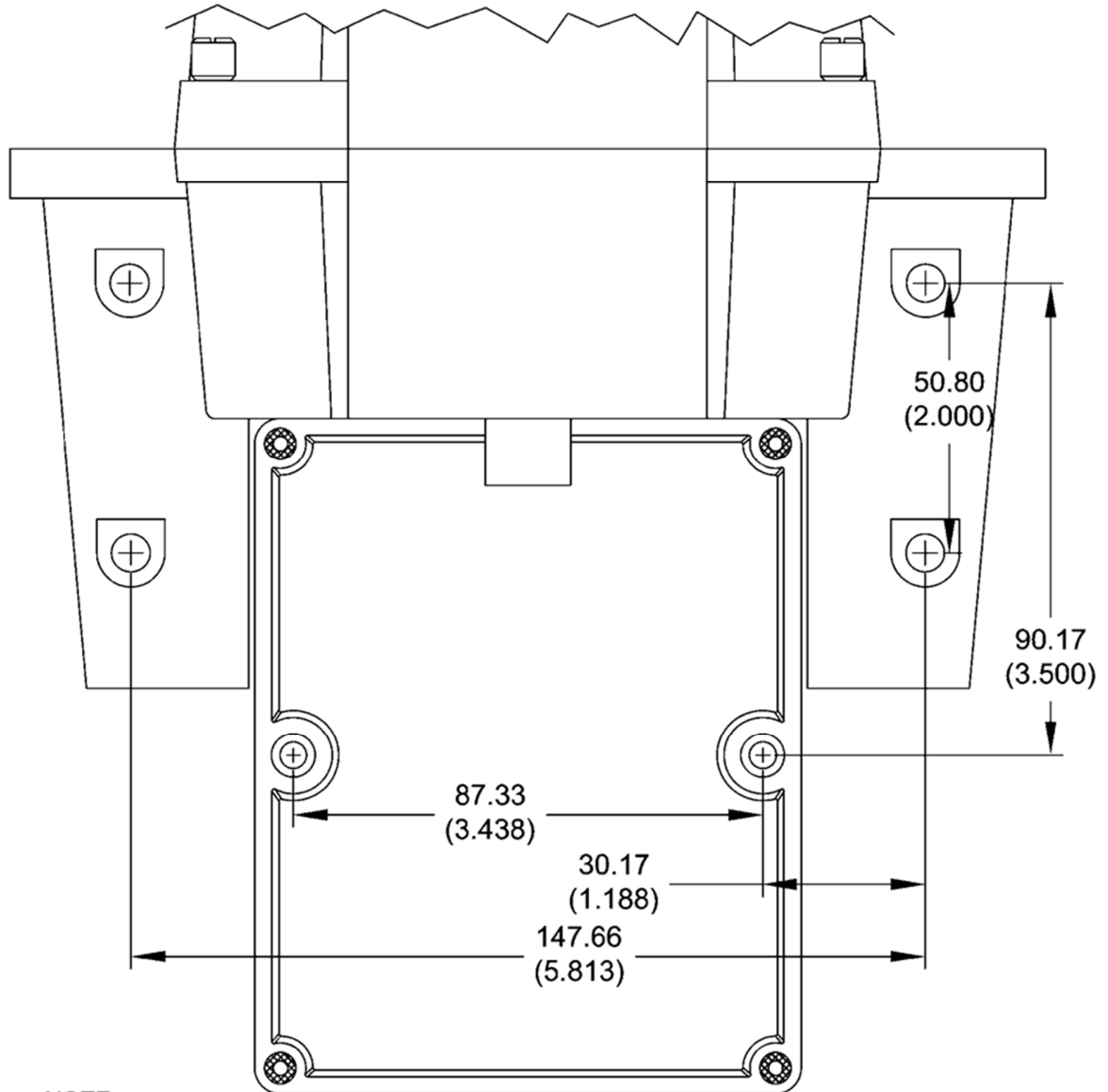

**NOTE:**

- 1) SEE THE MOUNTING INSTRUCTIONS IN THE MANUAL FOR MOUNTING HARDWARE SIZES.
- 2) PROVIDE AT LEAST 200 MM (8 INCHES) OF FREE SPACE ABOVE THE SENSOR FOR EASY REMOVAL OF THE FLOW HEAD AND INSERTION OF THE CALIBRATION STANDARDS.

REV 16-MAR-07



See the mounting instructions in the manual for mounting hardware sizes. Provide at least 200 mm (8 inches) of free space above the sensor for easy removal of the flow head and insertion of the calibration standards.





# Xylem |'zīləm|

- 1) The tissue in plants that brings water upward from the roots;
- 2) a leading global water technology company.

We're a global team unified in a common purpose: creating advanced technology solutions to the world's water challenges. Developing new technologies that will improve the way water is used, conserved, and re-used in the future is central to our work. Our products and services move, treat, analyze, monitor and return water to the environment, in public utility, industrial, residential and commercial building services settings. Xylem also provides a leading portfolio of smart metering, network technologies and advanced analytics solutions for water, electric and gas utilities. In more than 150 countries, we have strong, long-standing relationships with customers who know us for our powerful combination of leading product brands and applications expertise with a strong focus on developing comprehensive, sustainable solutions.

For more information on how Xylem can help you, go to [www.xylem.com](http://www.xylem.com)



Service and Returns:

Xylem Analytics Germany  
Sales GmbH & Co. KG

WTW

Dr.-Karl-Slevogt-Str. 1  
82362 Weilheim  
Germany

Tel.: +49 881 183-325

Fax: +49 881 183-414

E-Mail [wtw.rma@xyleminc.com](mailto:wtw.rma@xyleminc.com)

Internet: [www.WTW.com](http://www.WTW.com)

**xylem**  
Let's Solve Water

Xylem Analytics Germany GmbH  
Dr.-Karl-Slevogt-Str. 1  
82362 Weilheim  
Germany